

CROFTER LIFE ON THE
WEST DONEGAL
SEABOARD

CROFTER LIFE ON THE
WEST DONEGAL
SEABOARD

PATRICK O'NEILL

1940



Donegal Council Archives

P/146(2)

Donegal County Council Archives

Volume 2.

CONTENTS.

FIGURES 1 - 32.

PLATES 1 - 22.

PATRICK O'NEILL.

APRIL, 1940

Natural
Vegetation





-  grass and arable land
-  moorland, hill, pasture, mountain-waste
-  woodland.

FIG. 1

Annual
Rainfall



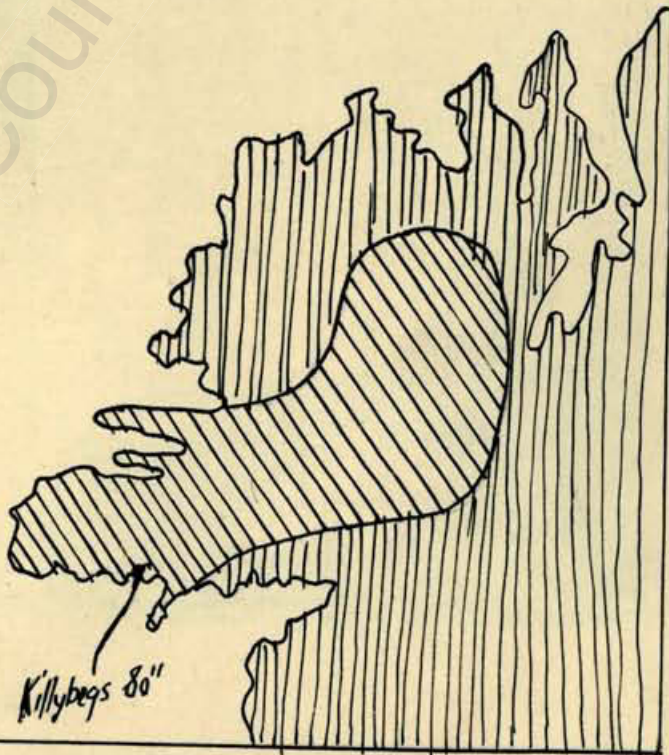

-  40-60"
-  60-80"

FIG. 2.

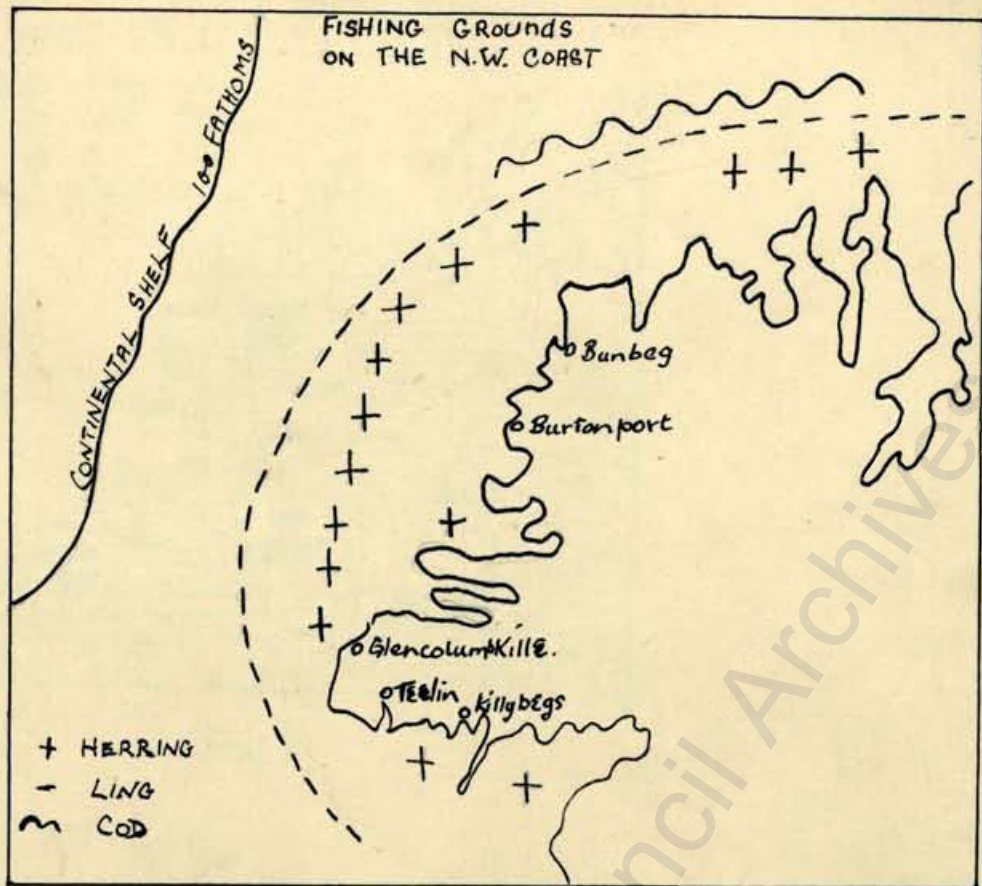

FIG. 3.

ling where?

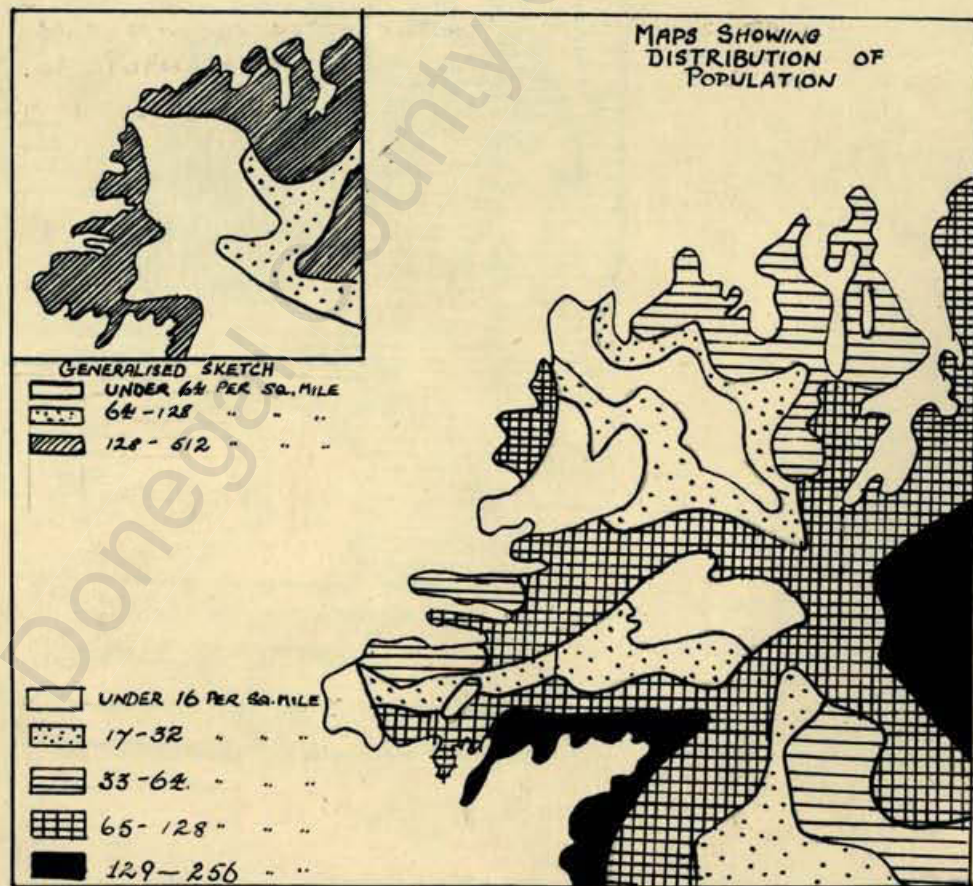

FIG. 4

Part of

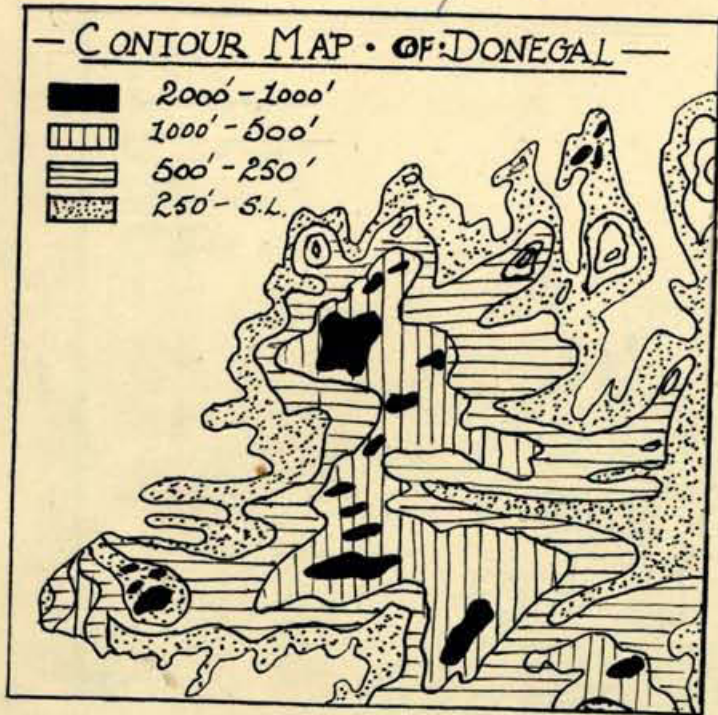

FIG. 5.

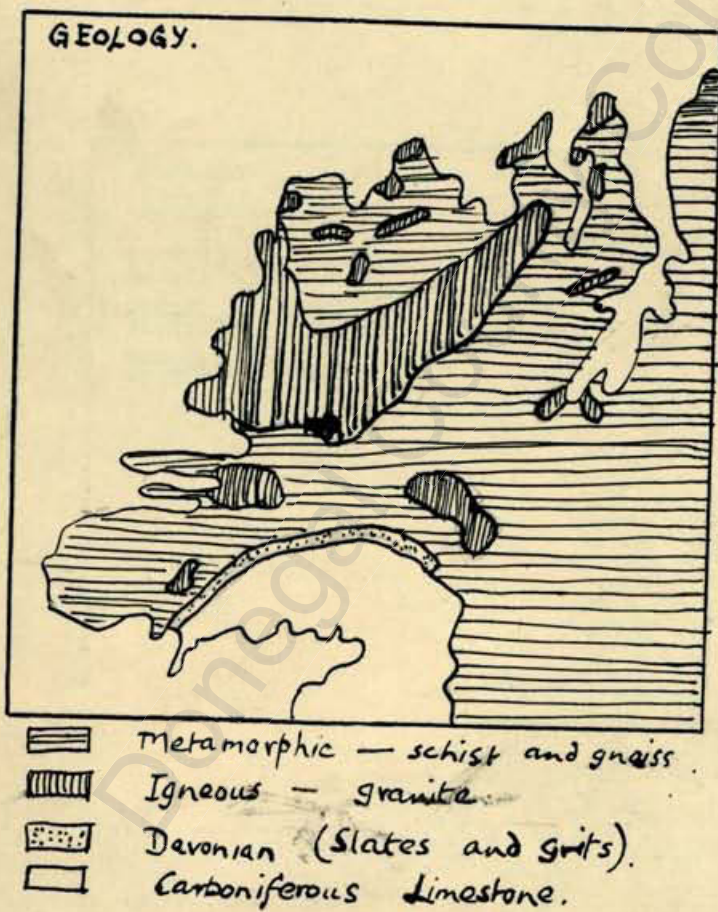

FIG. 6.

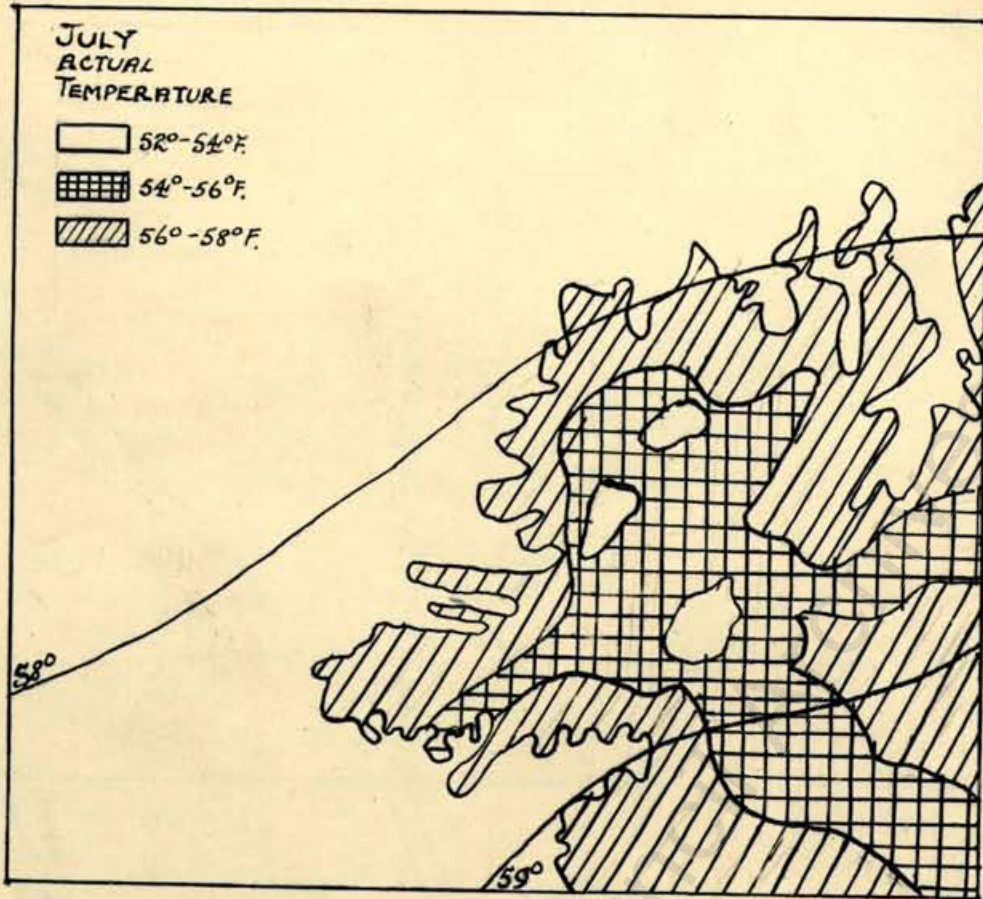

FIG. 7

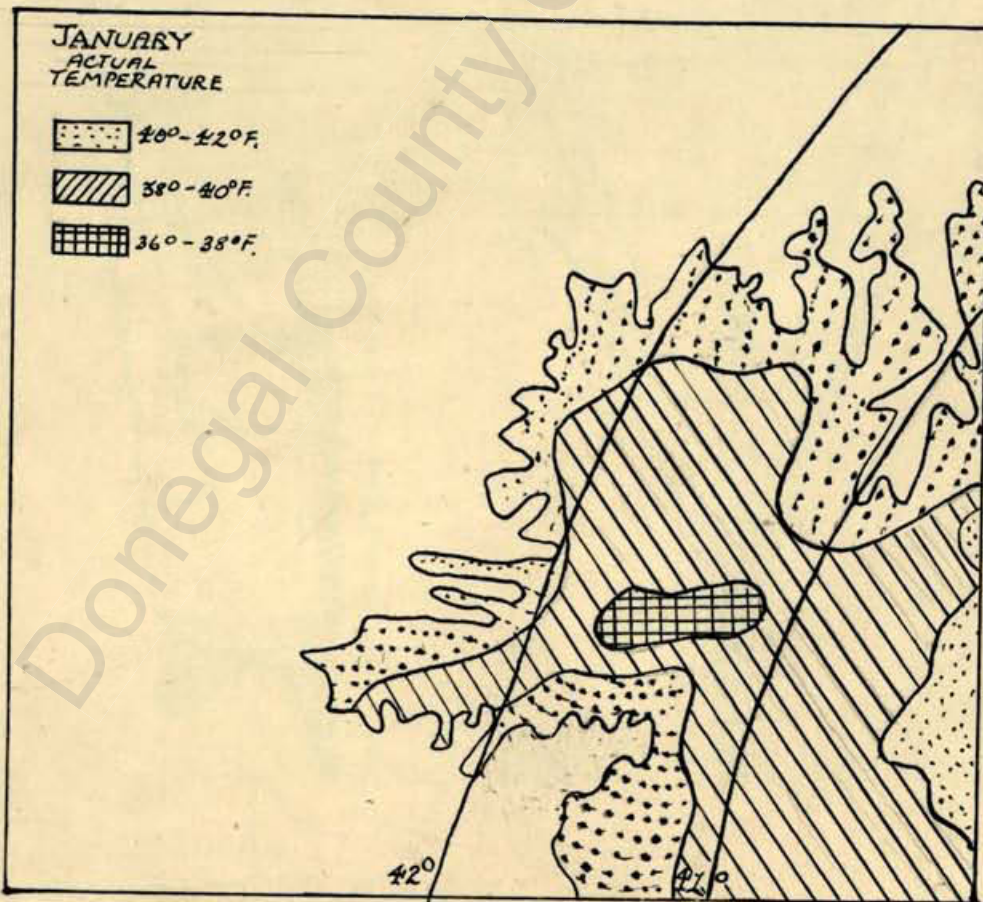
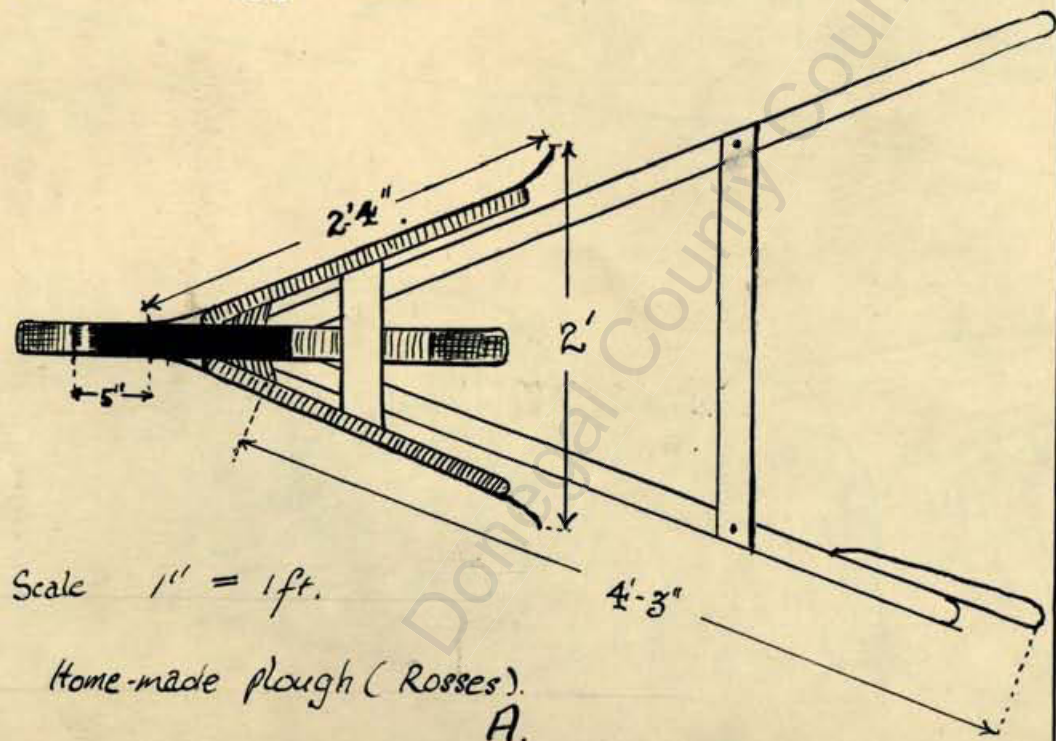
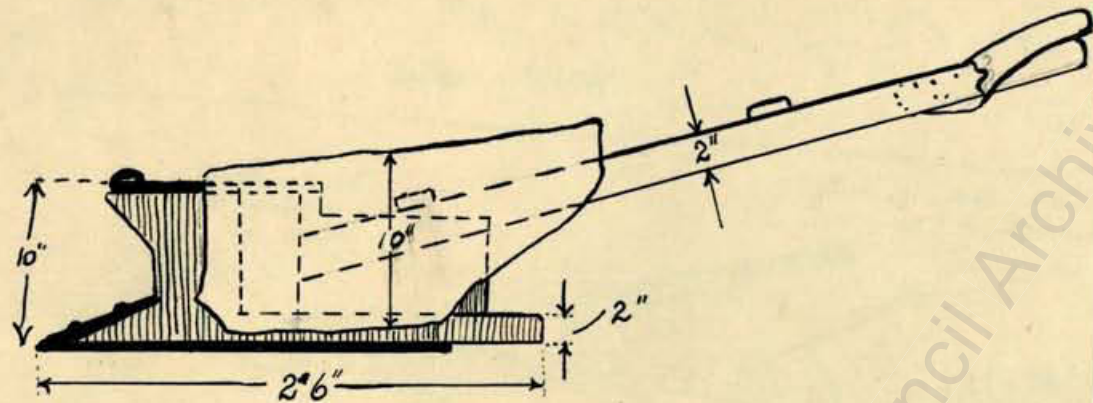

FIG. 8.



Scale 1" = 1ft.

Home-made plough (Rosses).

A.

FIG. 9.

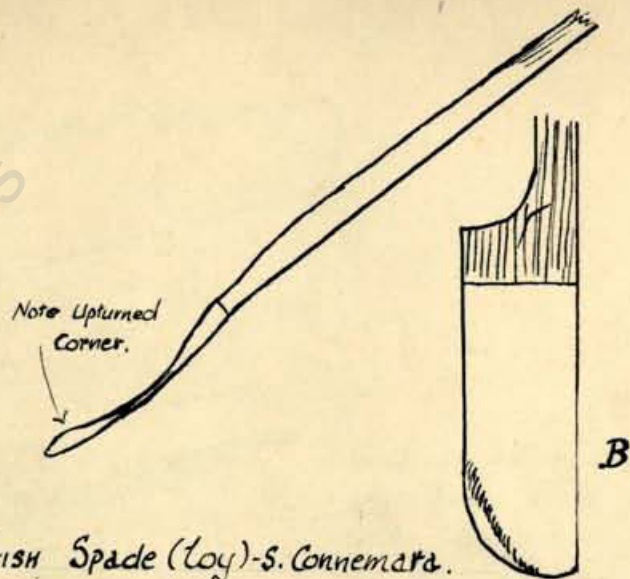

Irish Spade (loy)-S. Connemara.

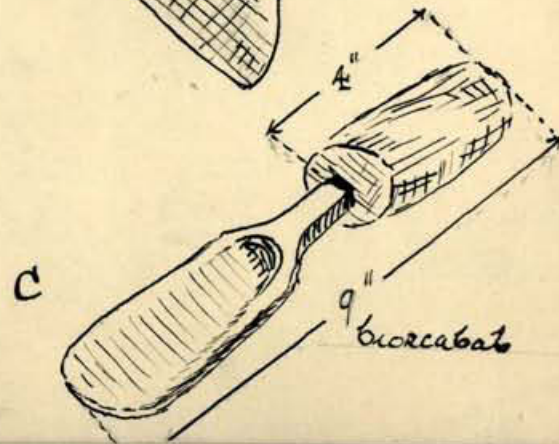
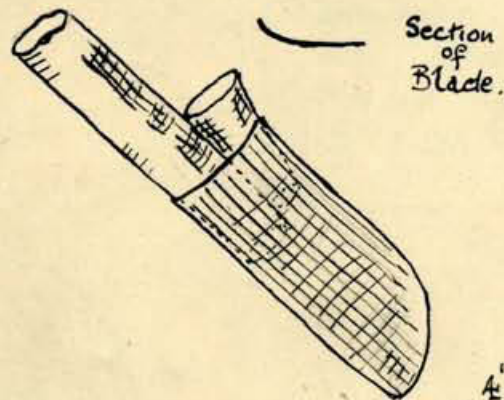

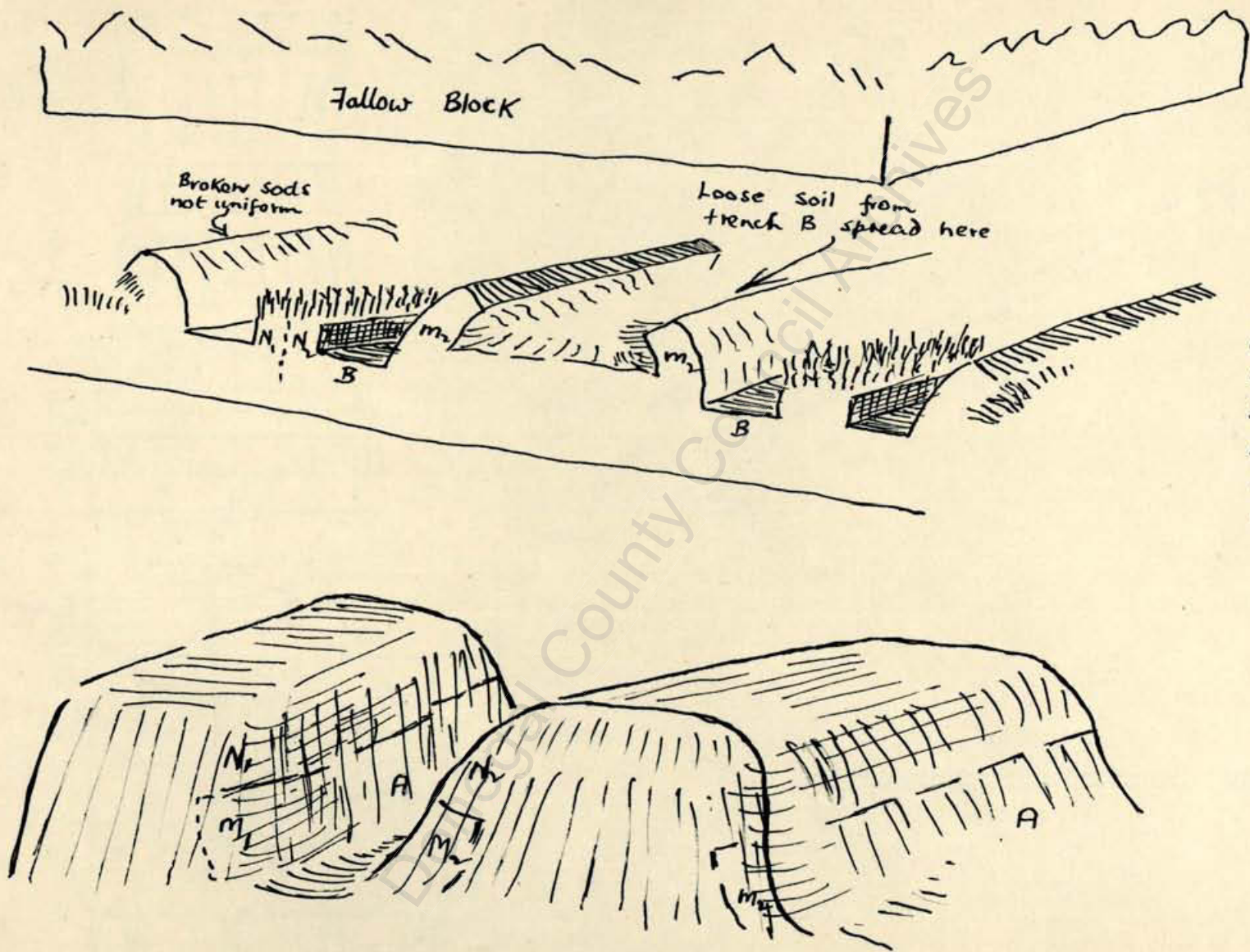

First series of sods M₂ dug from B to form first wall of new rig. Soil from B then spread on grass between M₂, M₂. When N₂ has been added trench A is deepened by using its soil to build up rig.

FIG. 10.

but it is reasonable to expect

Donegal County Council Archives

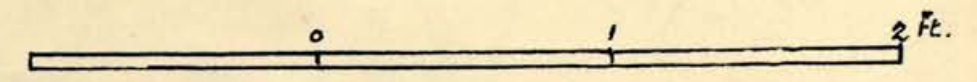
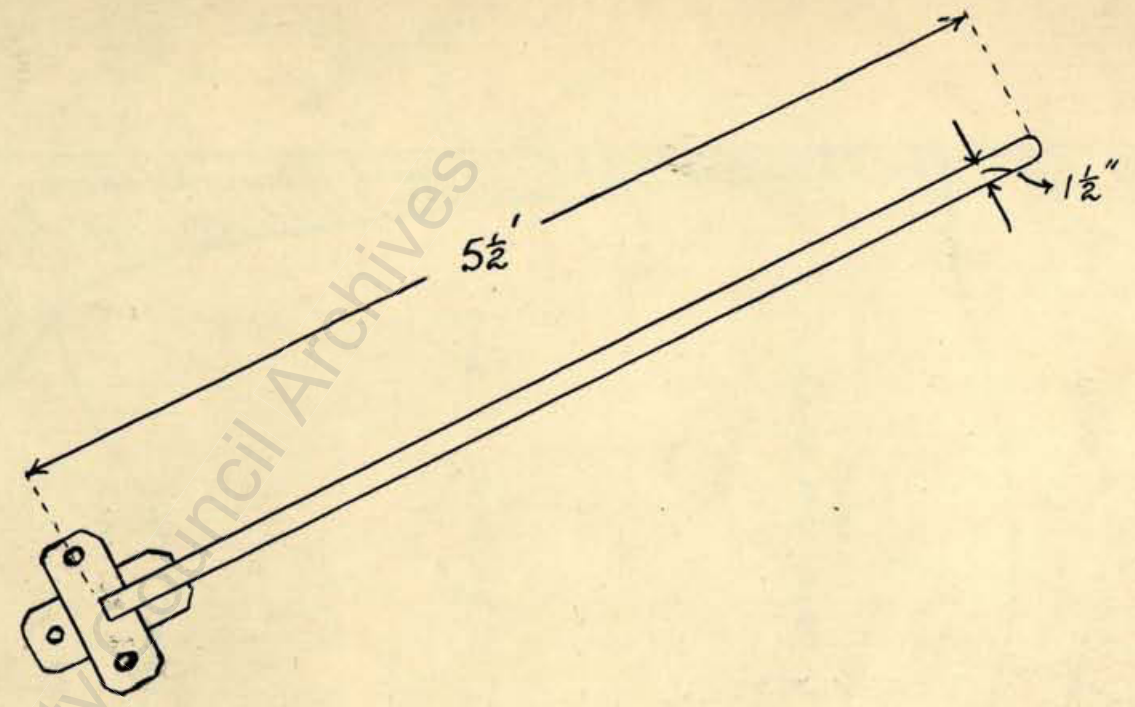
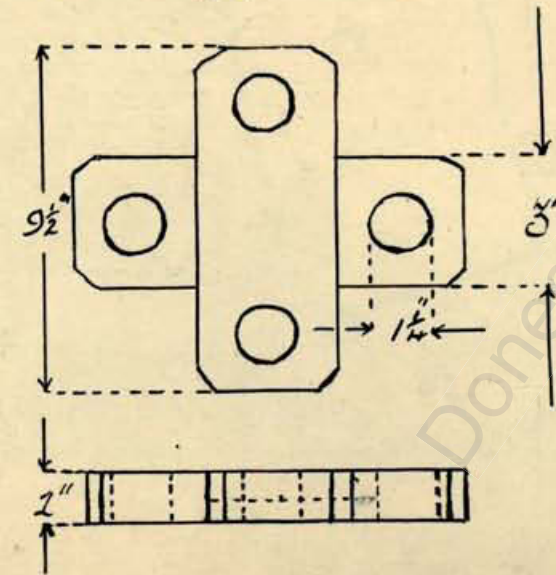
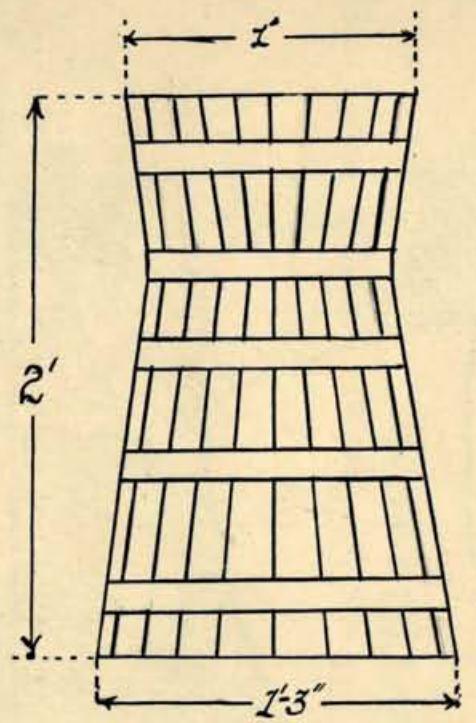
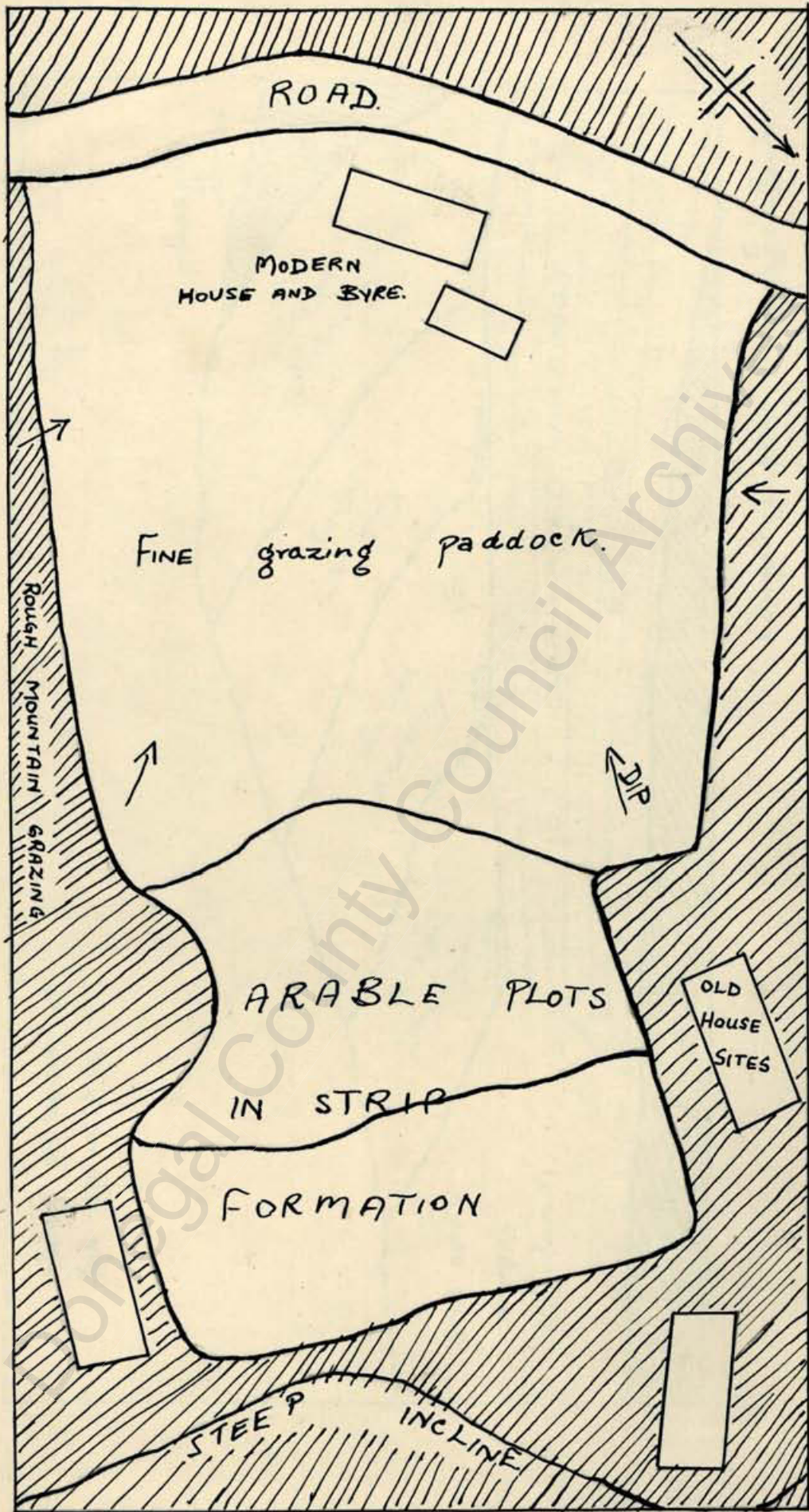
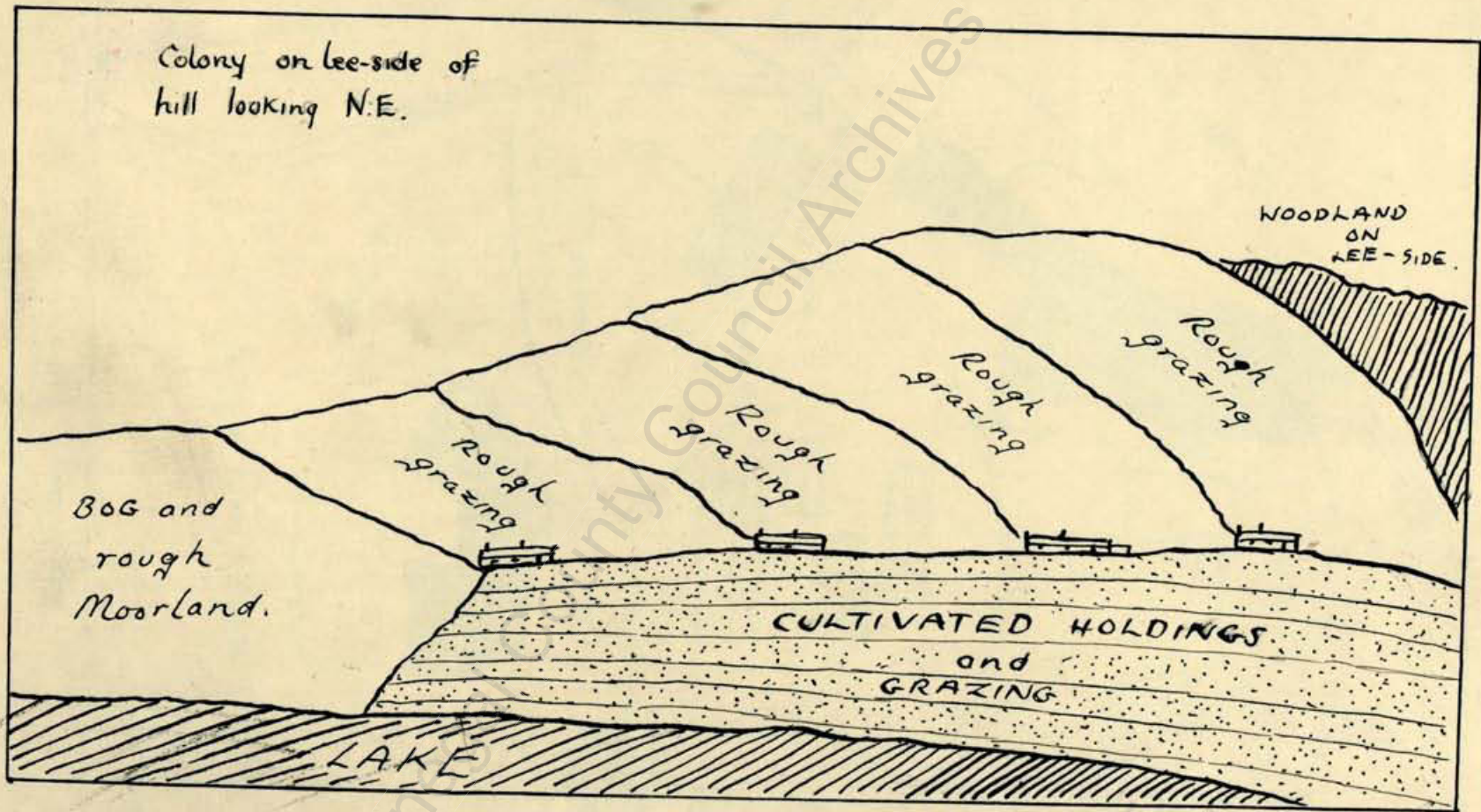

FIG. 11.



BALLY MIN SHAMAR (Kilmacrenan).

FIG. 12.



Cleengort (Upper Travenagh Bay)

FIG. 13.

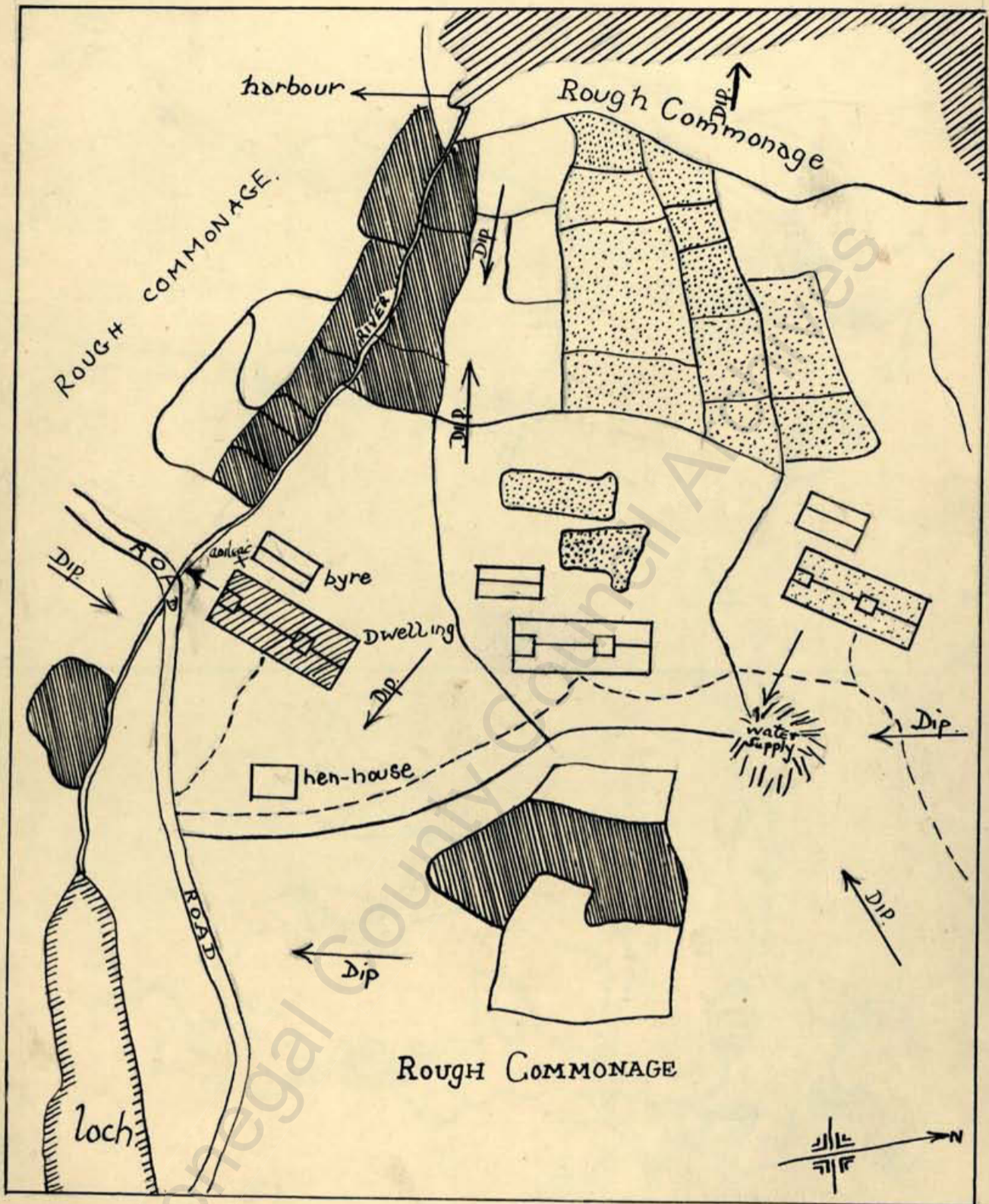

Altnaquire (Ranafast).

Fig. 14.

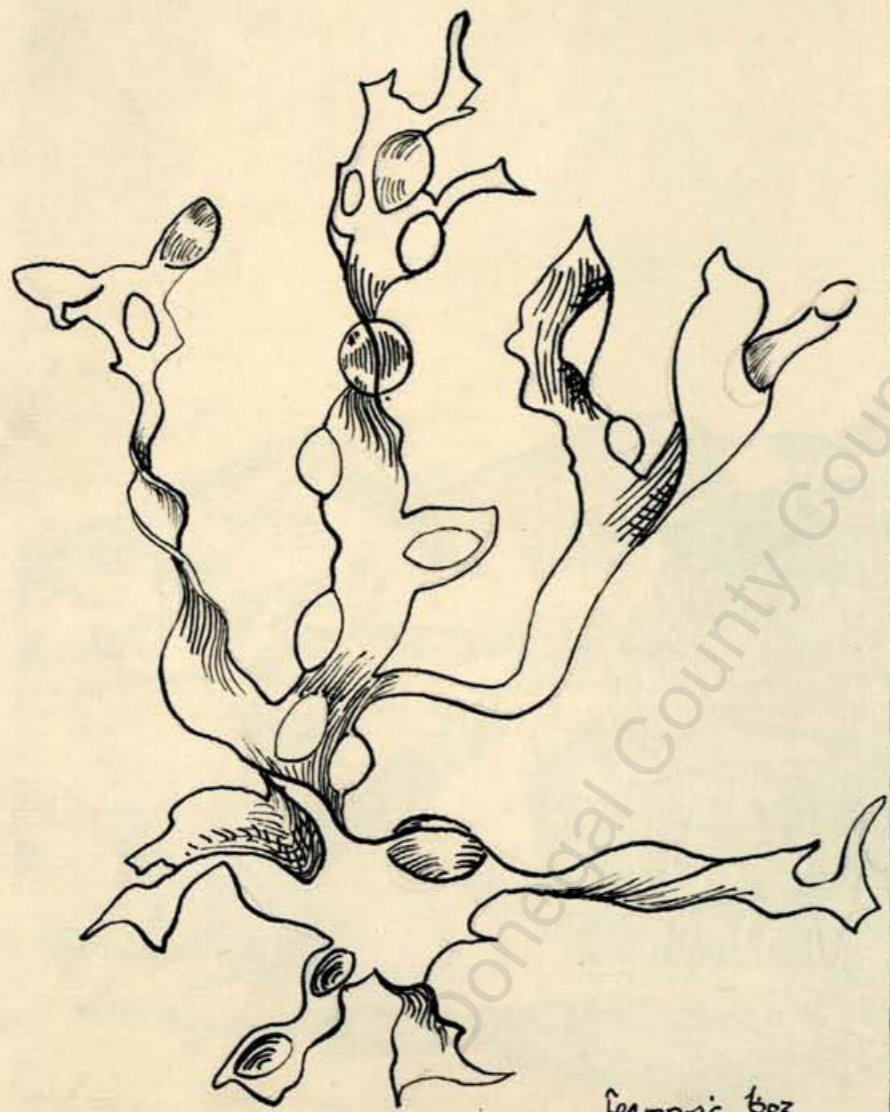

feamgac 603
A

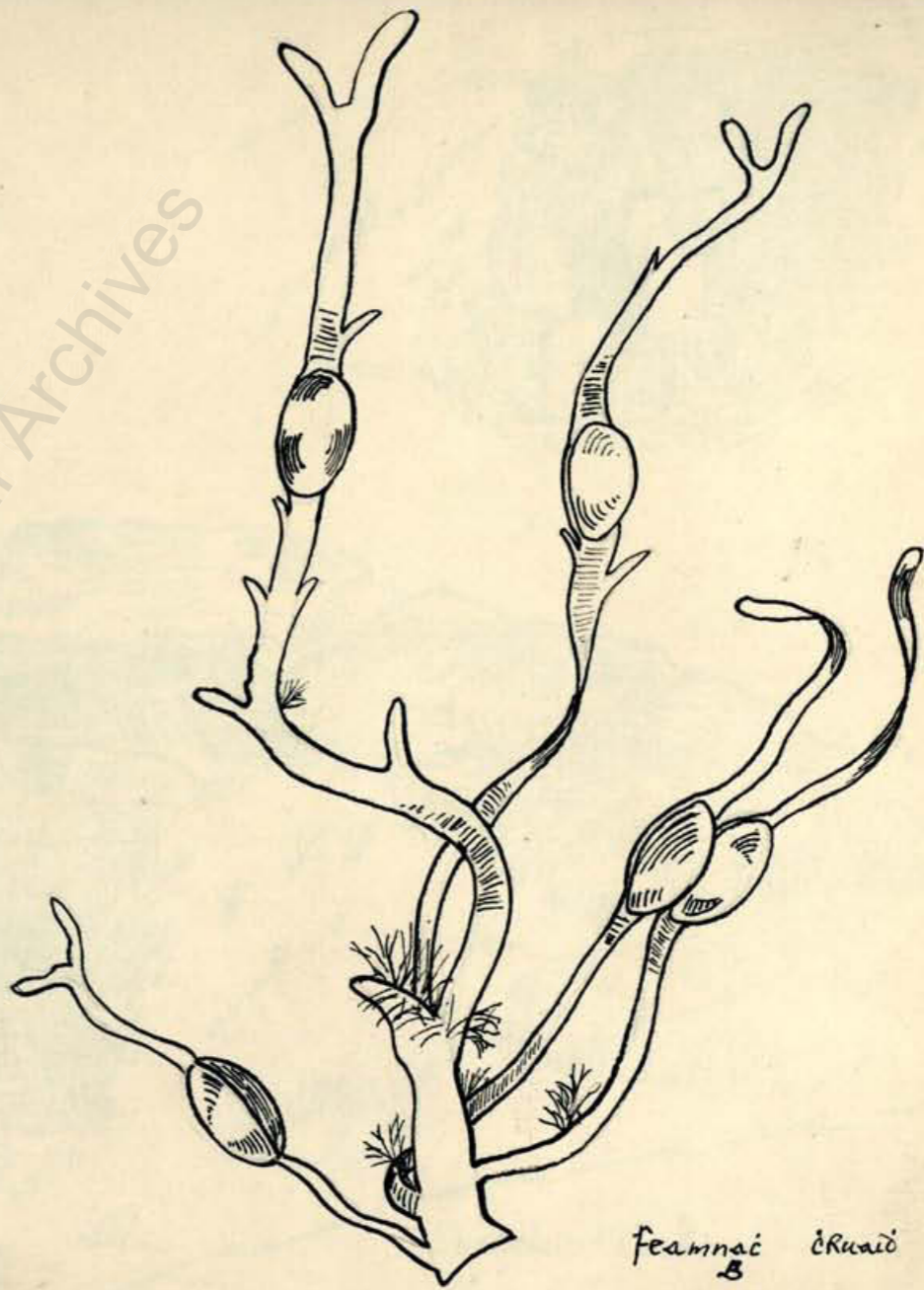

feamgac 8
cruaid

FIG. 15.

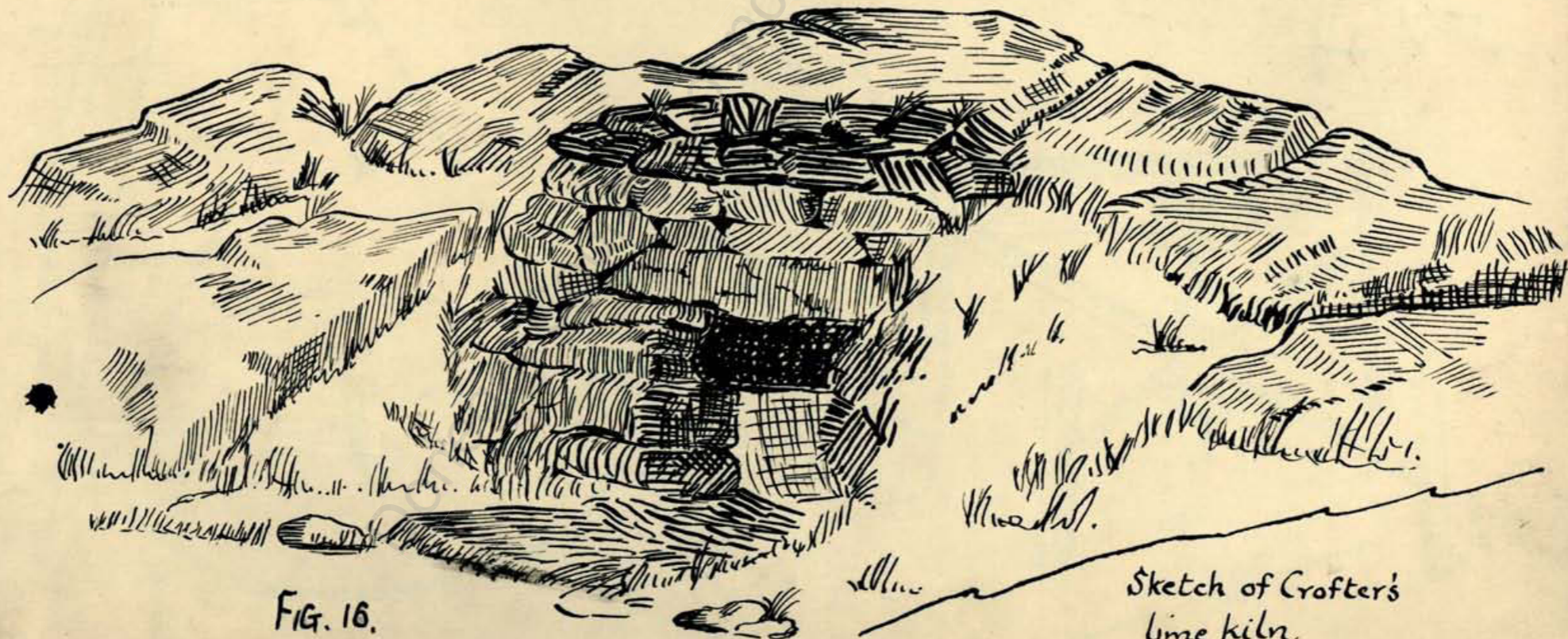
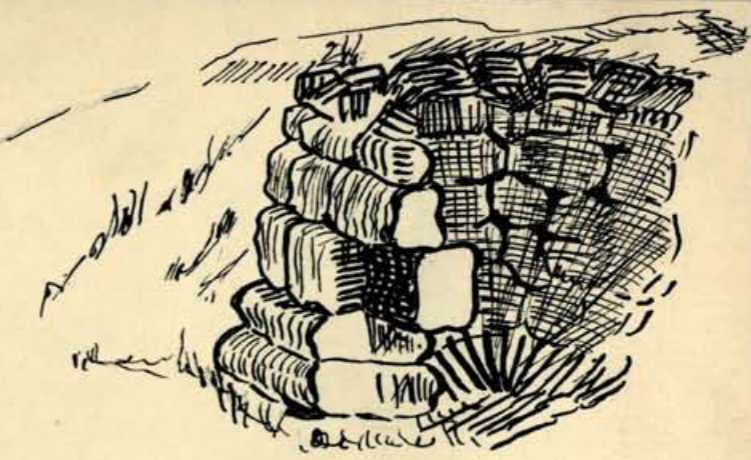

FIG. 16.

Sketch of Crofter's
lime kiln.



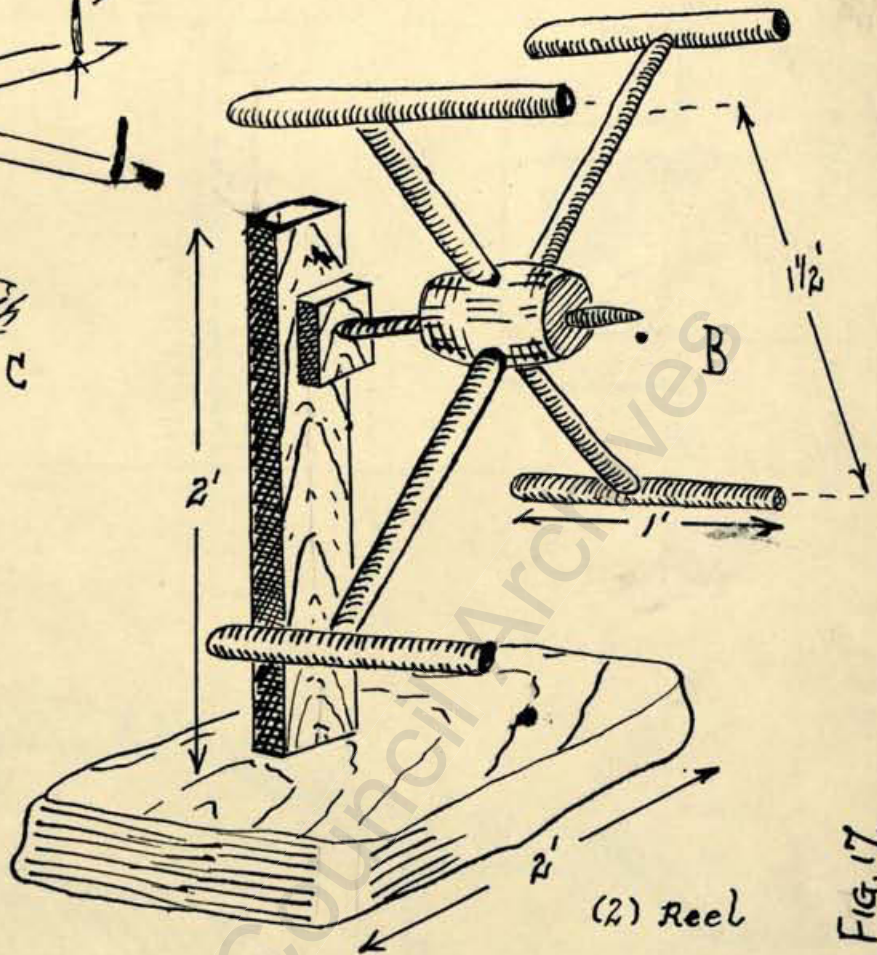
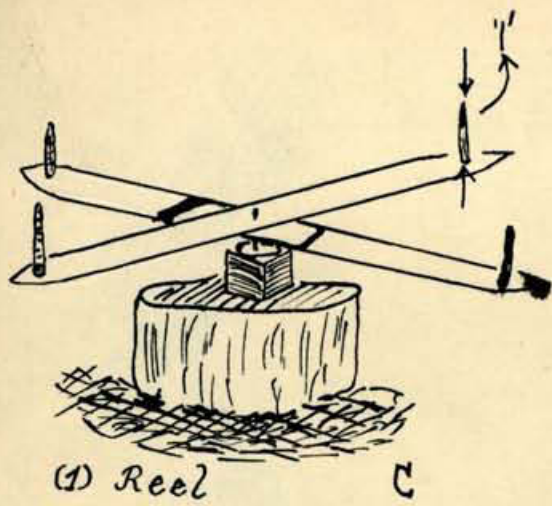
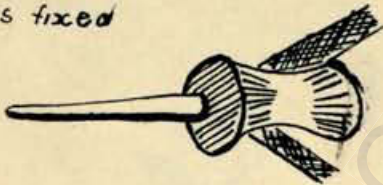
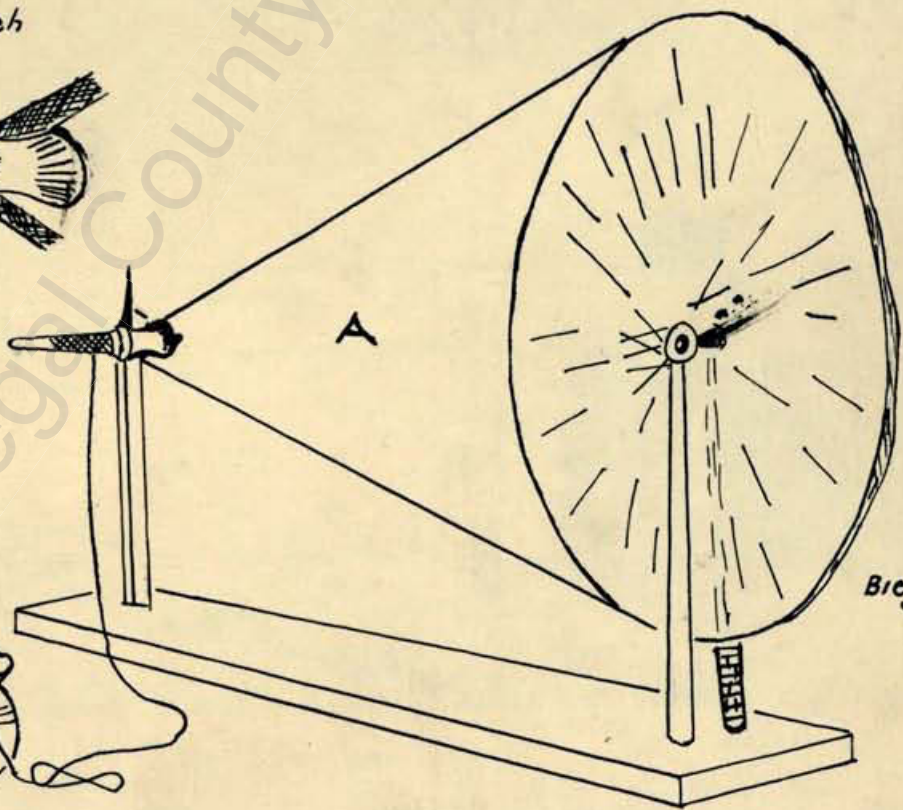

FIG. 17.

Common spool into which
a metal bobbin holder
is fixed



Pot for holding
yarn



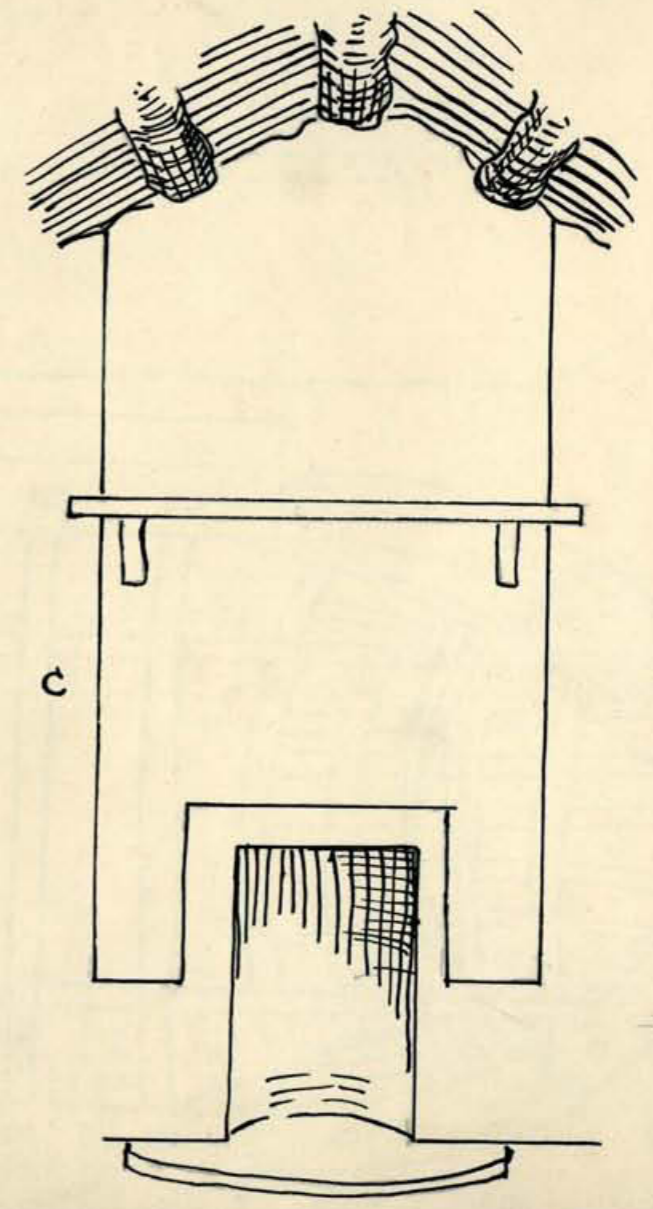
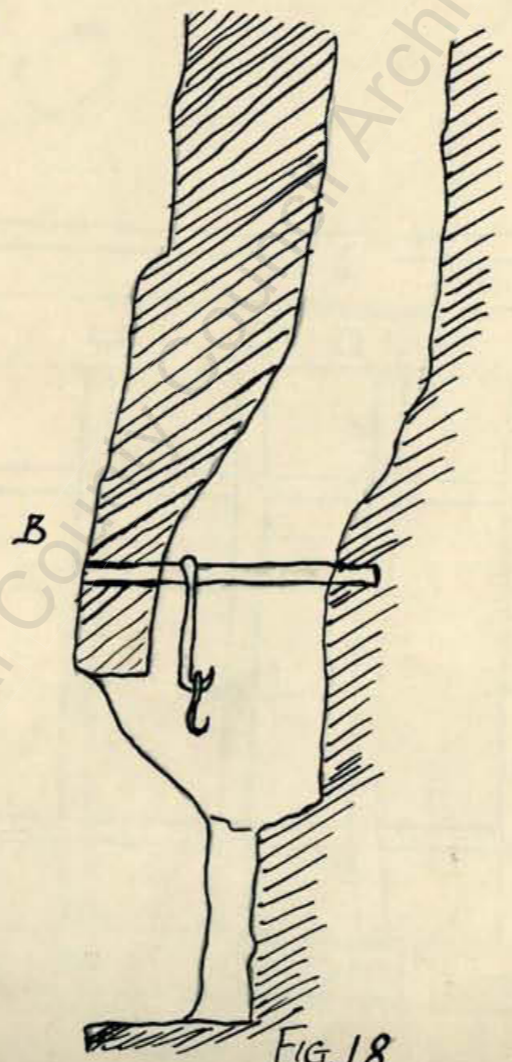
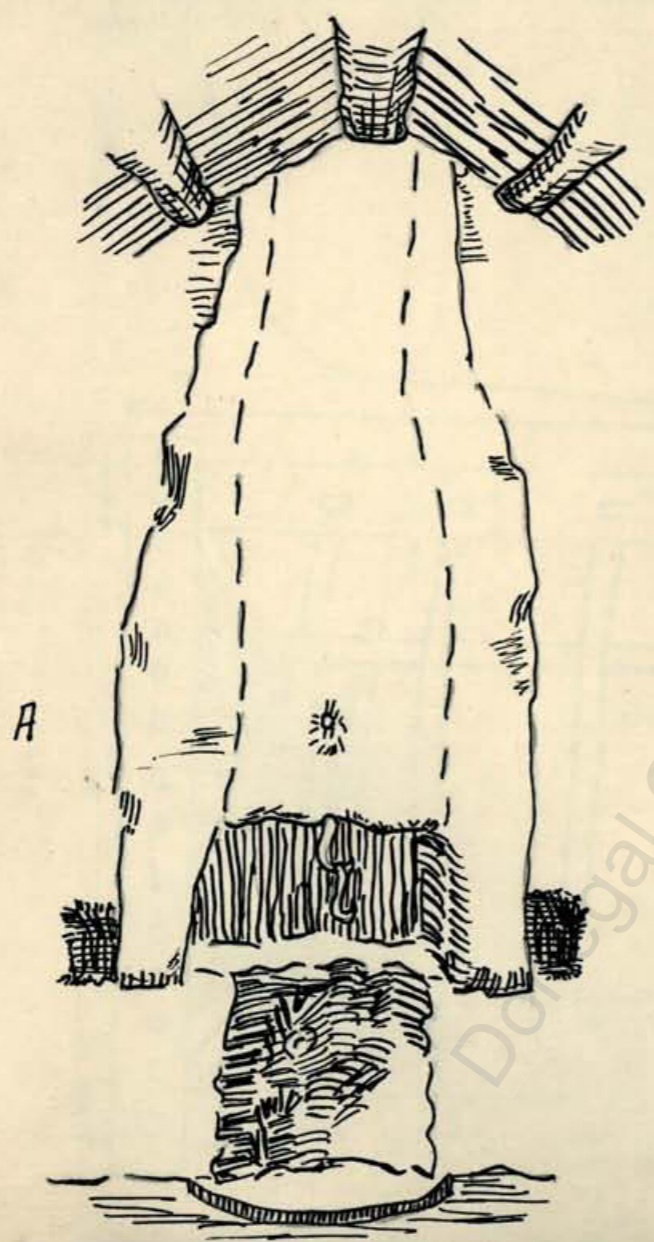

FIG. 18

Scale 1 - 1 ft.

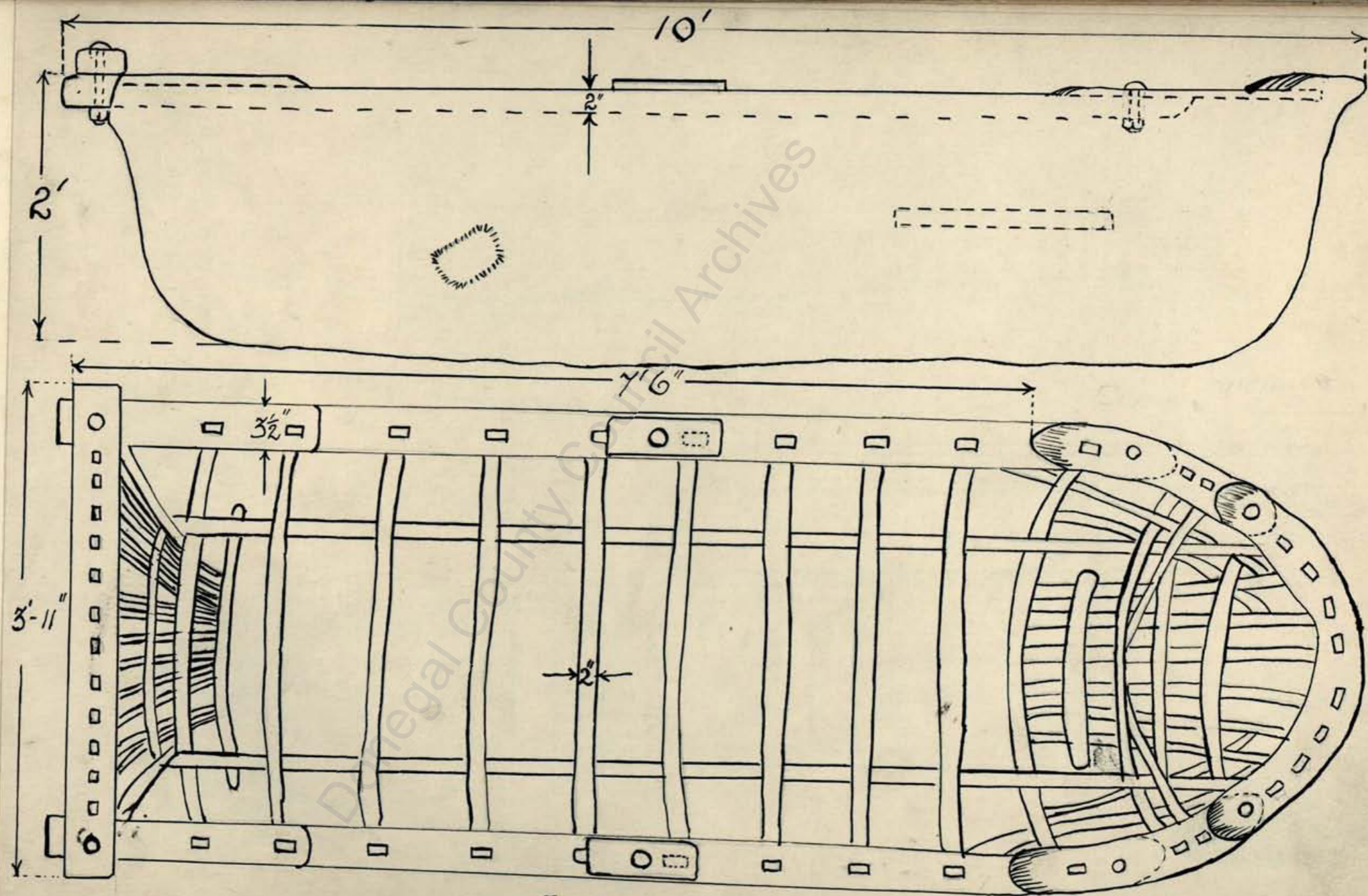
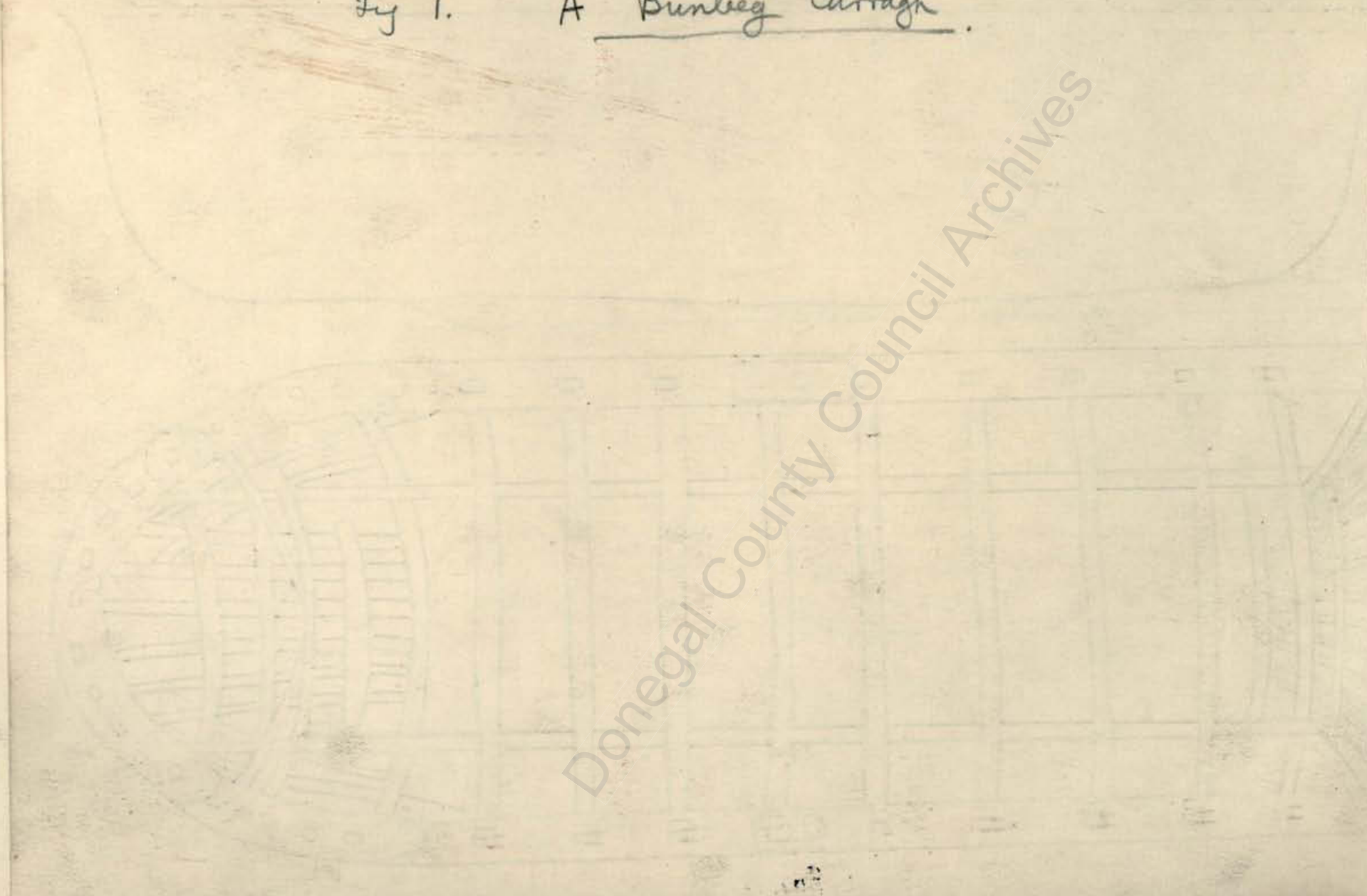

FIG. 19.

Scale 1" = 1ft.

Fig 1. A Bunbeg Curragh.



Donegal County Council Archives

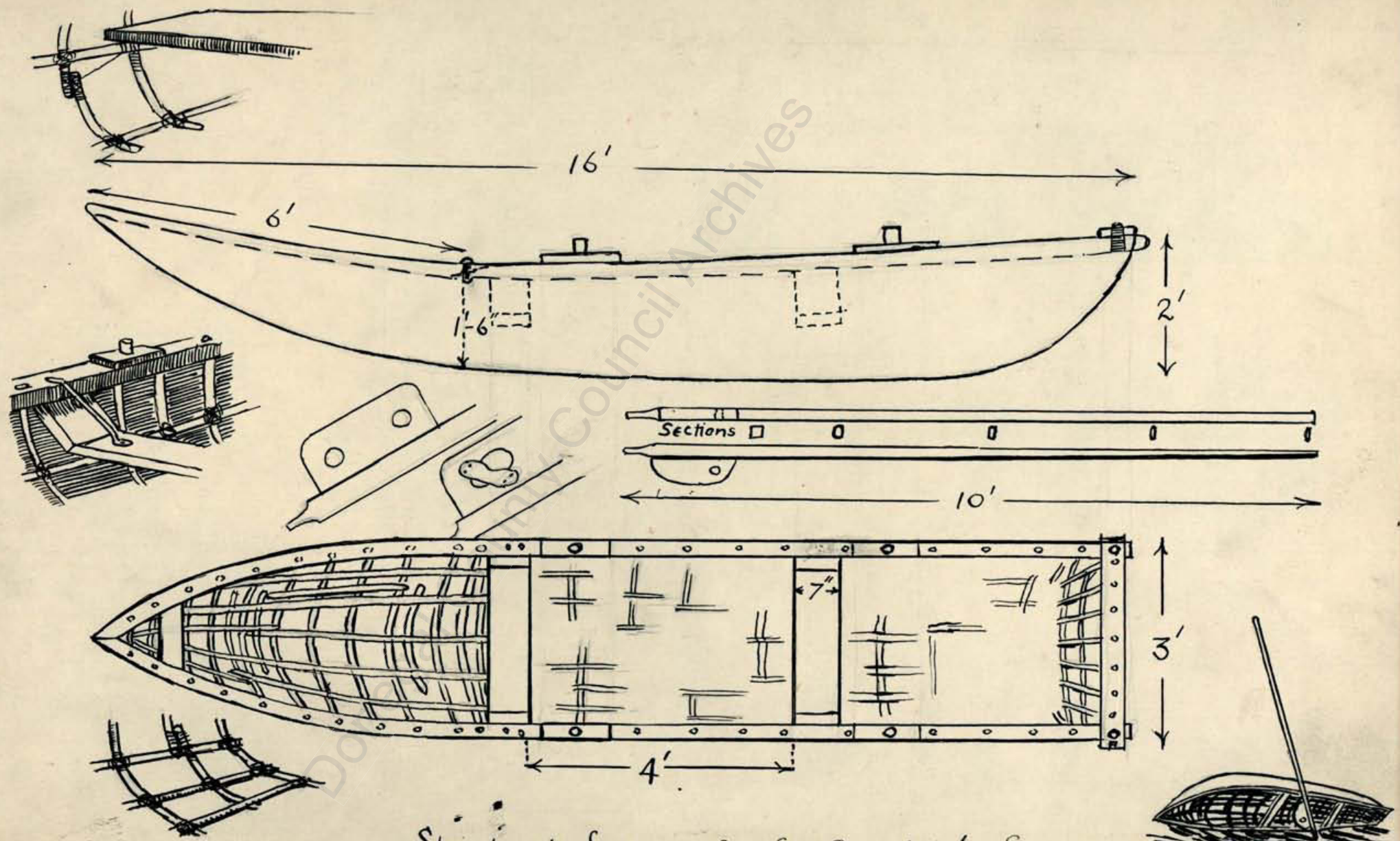

Structural features of a Sea Curragh (16) Scale 1" = 2 ft.
 FIG. 20.

Fig 2.

A Sheephaven Curragh

Donegal County Council Archives

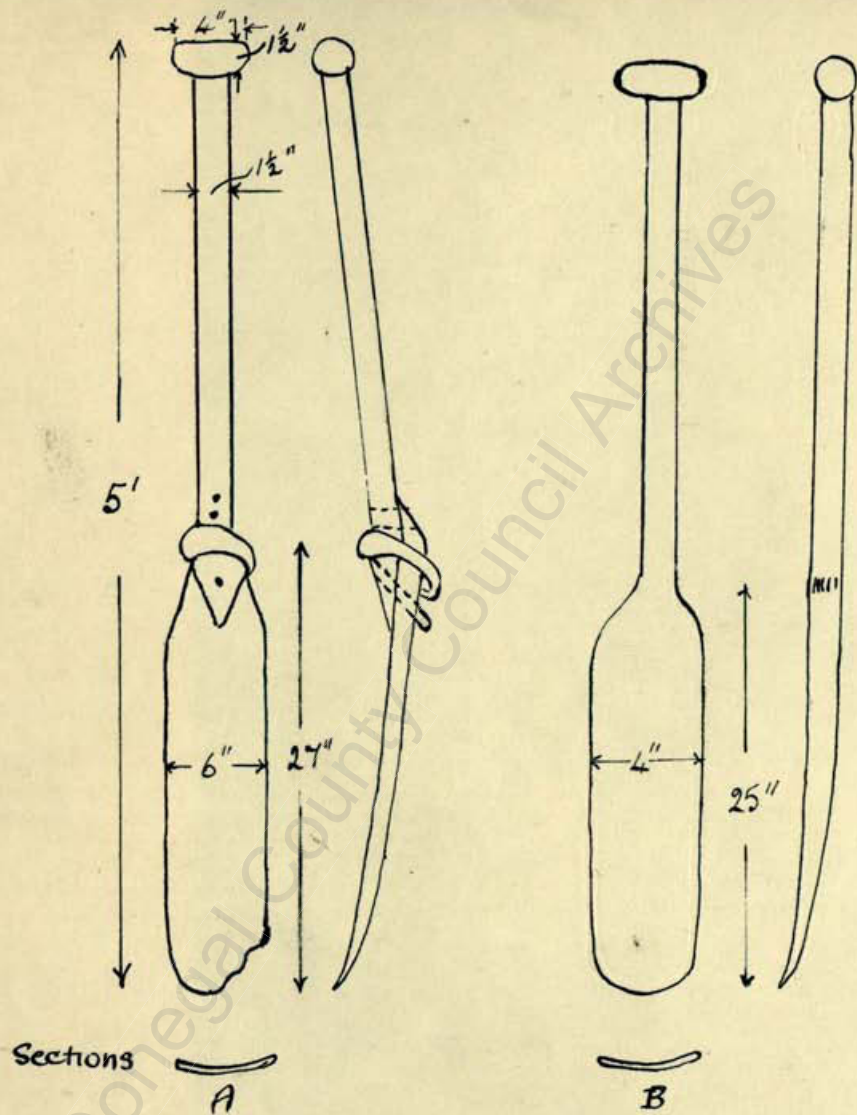
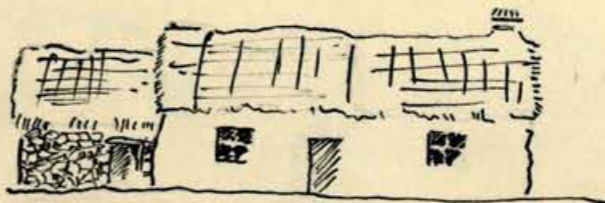
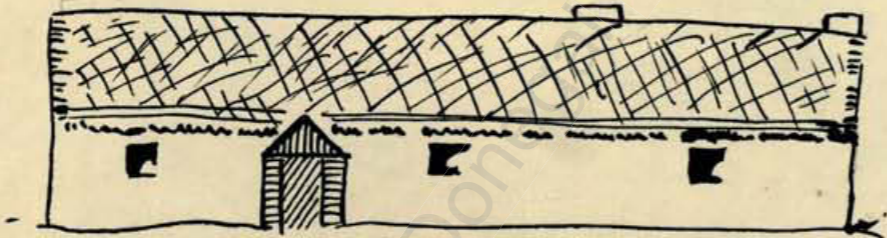
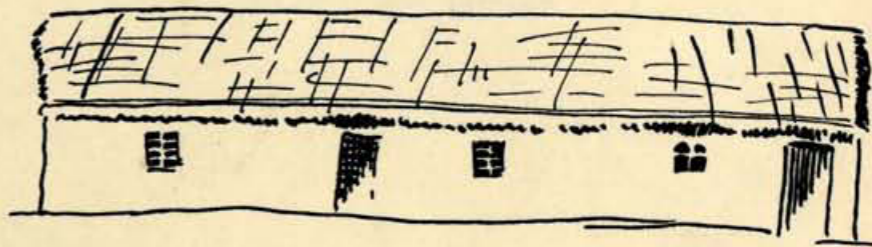
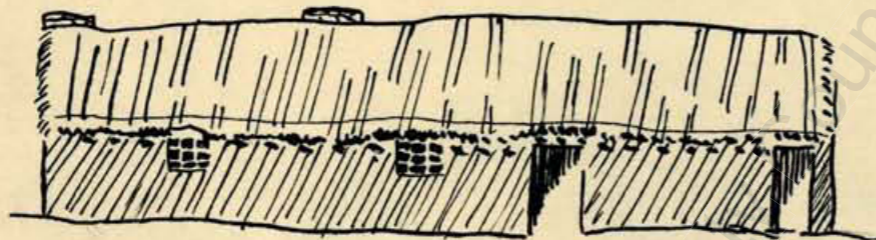
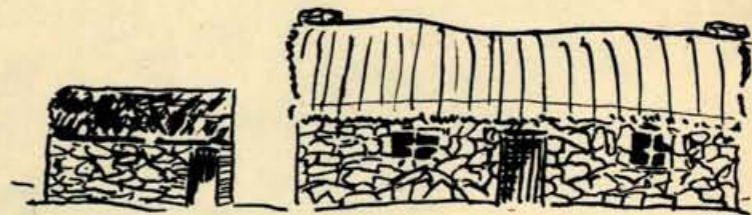
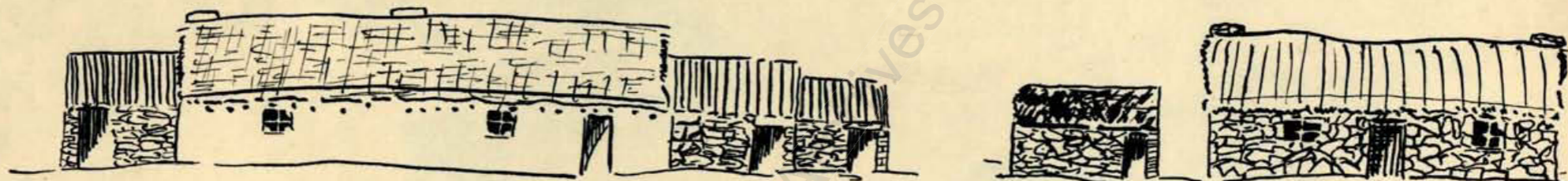
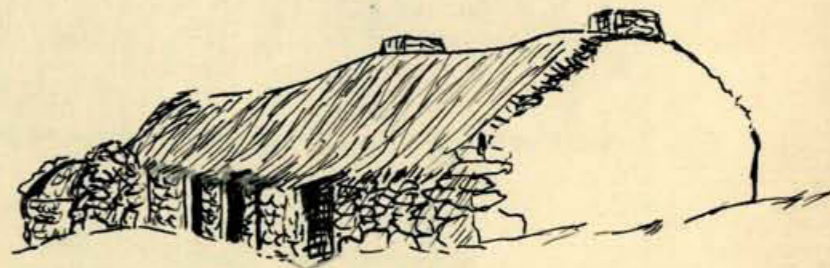
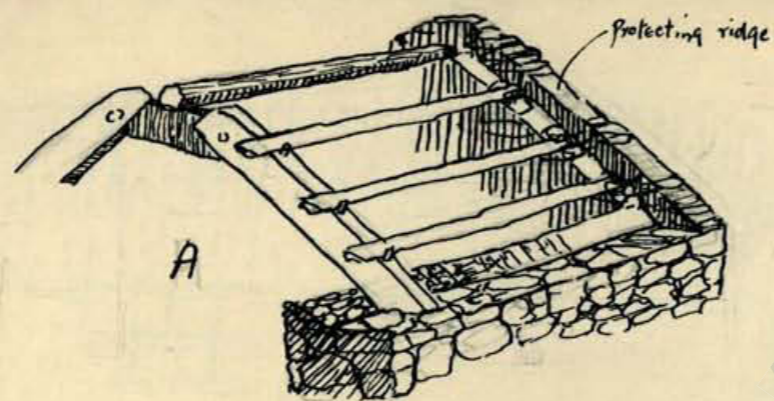

FIG. 21.



HOUSE TYPES LOCATED ALONG WESTERN SEABOARD AND SHOWING.
ESPECIALLY DEVELOPED BY ACCRETION. FIG. 22.



REAR VIEW SHOWING CAILLEACH.

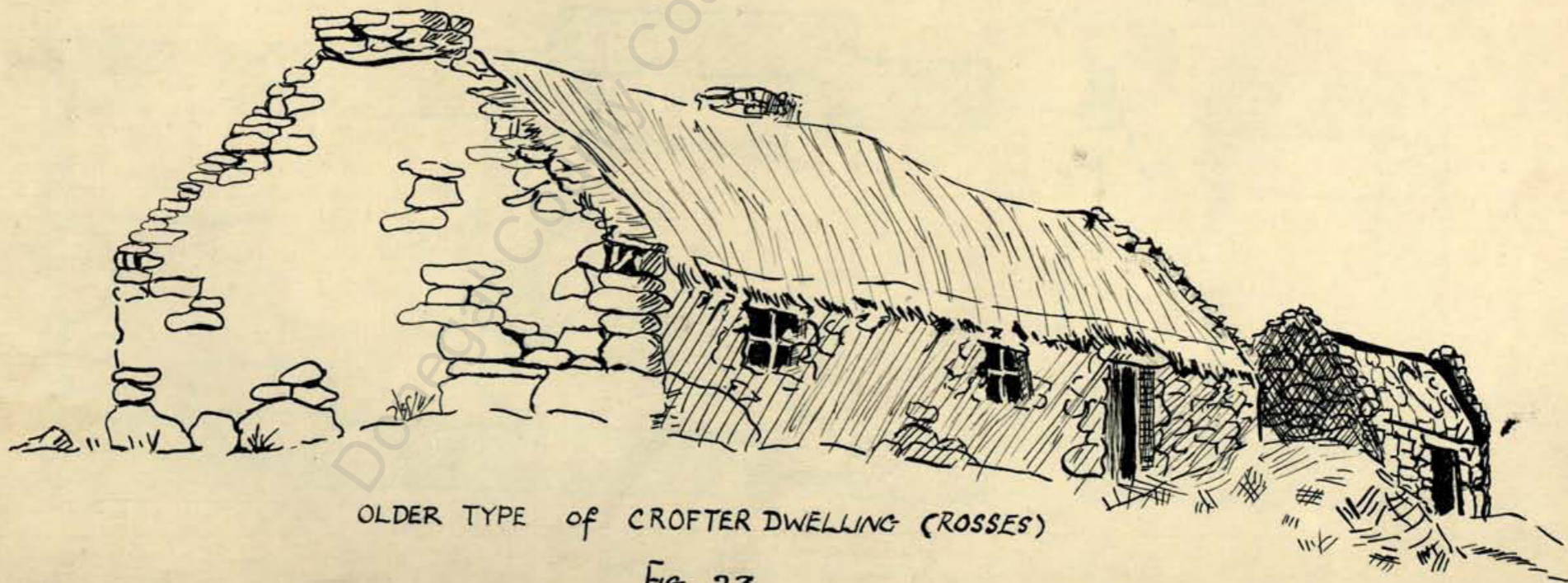

OLDER TYPE OF CROFTER DWELLING (ROSSES)

FIG. 23.

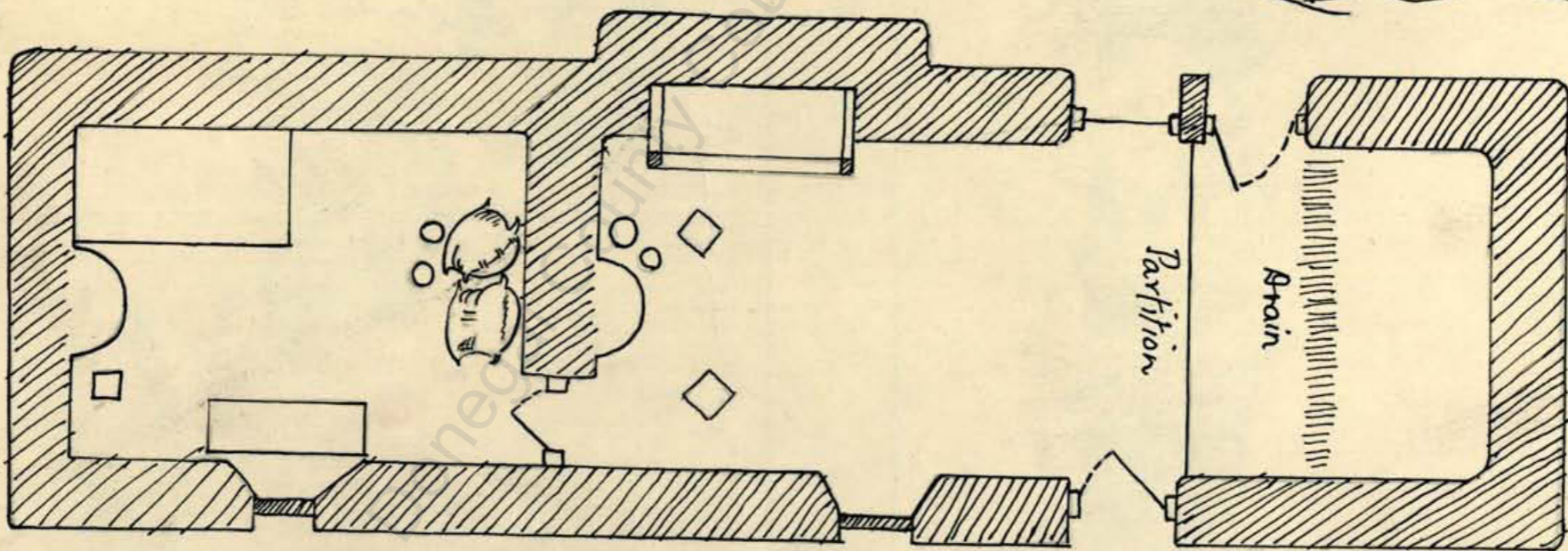
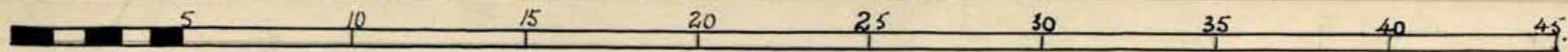

FIG. 23 (Derrynamansher, Lower Rosses)

IRISH HOUSE TYPES 1837.



Ballinought (Co. Cavan).

FIG A.

FIG. 2A.

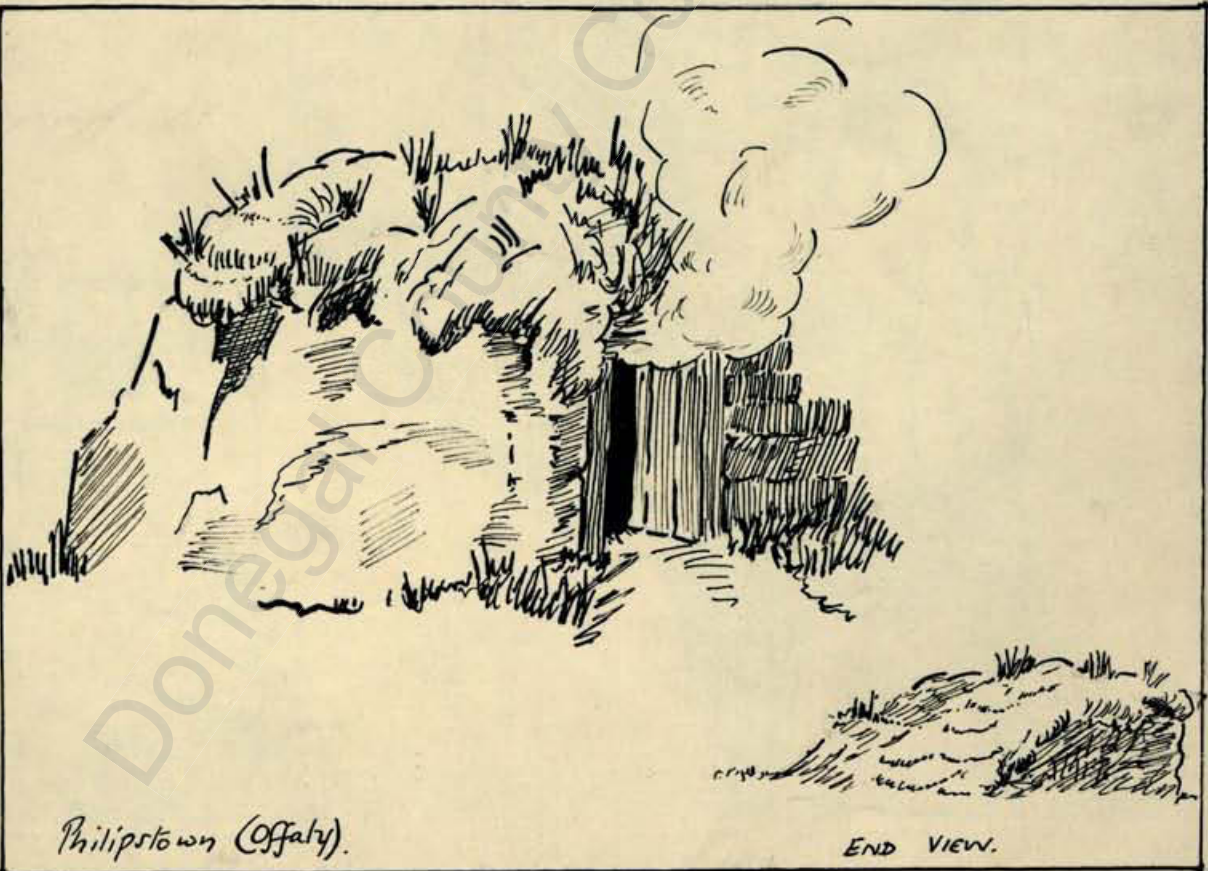

Philipstown (Offaly).

END VIEW.

FIG B.

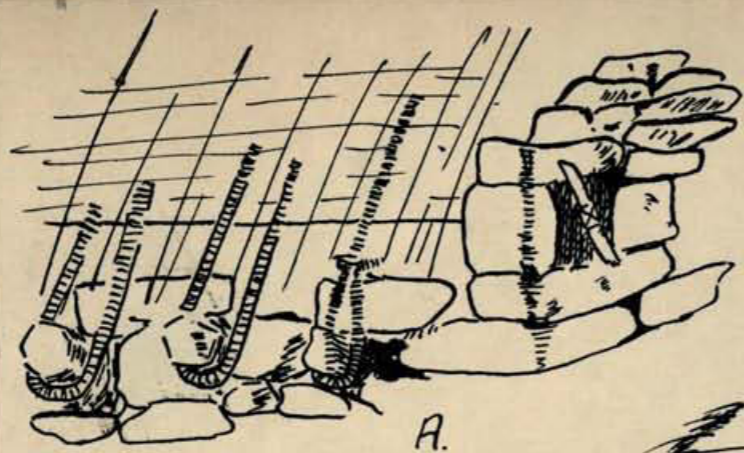

A.

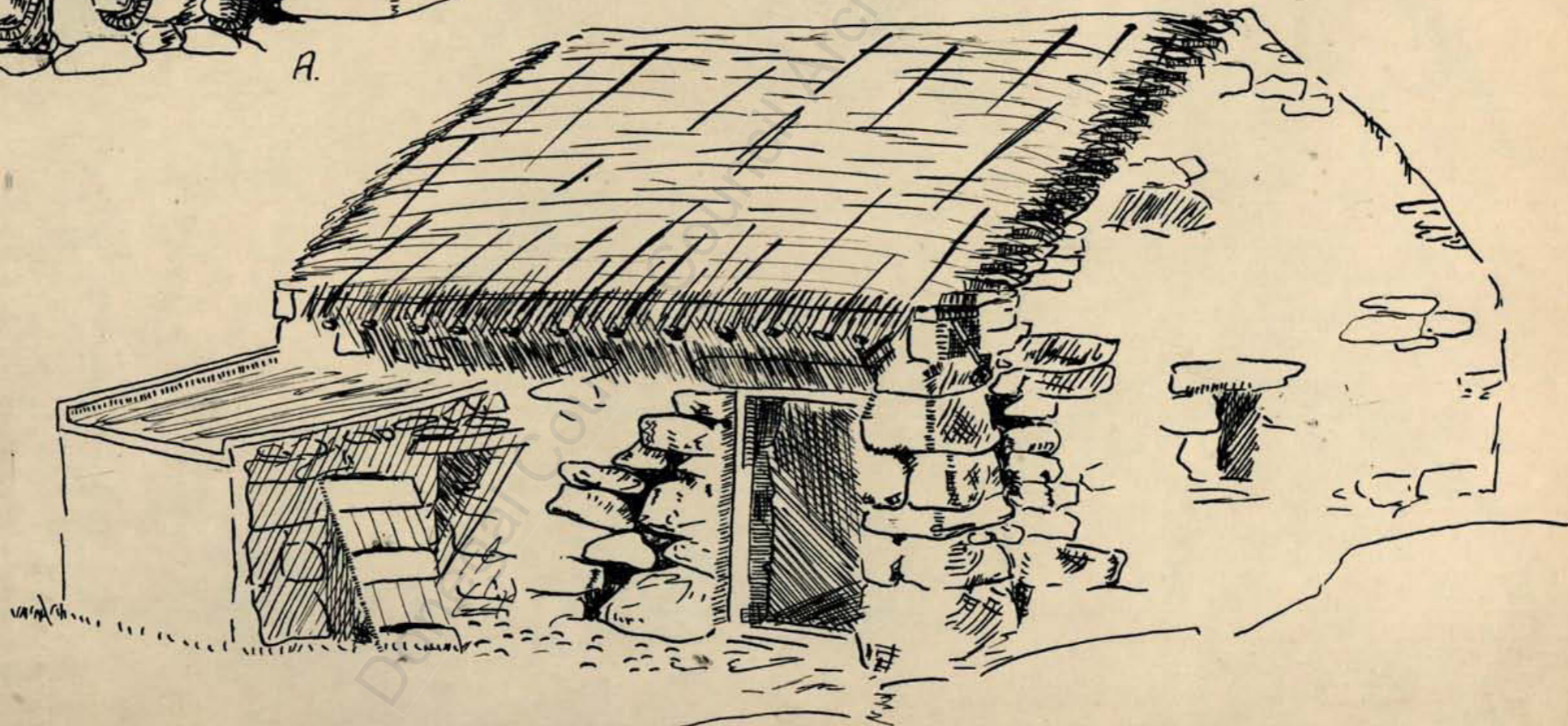

FIG. 25.

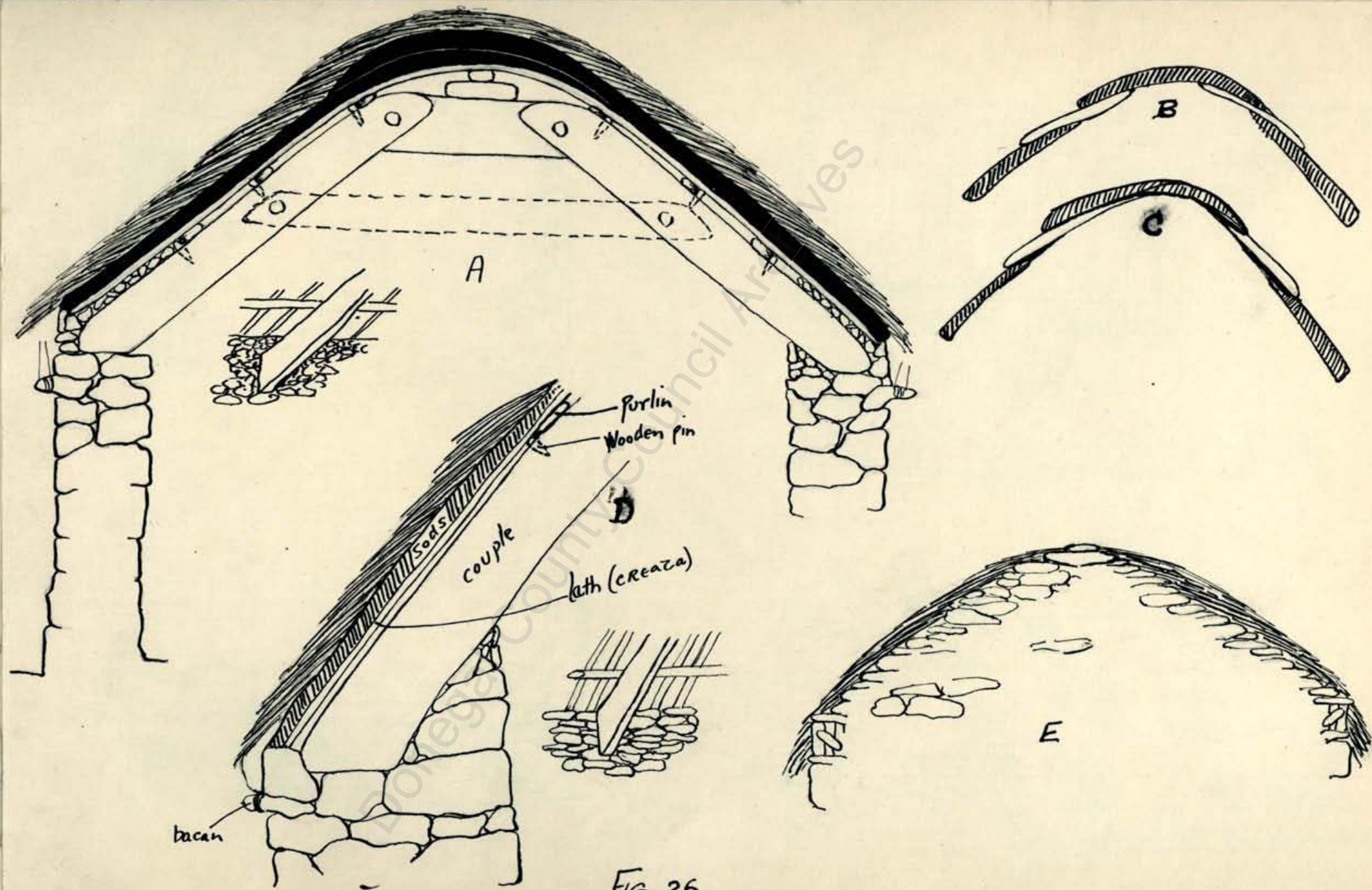
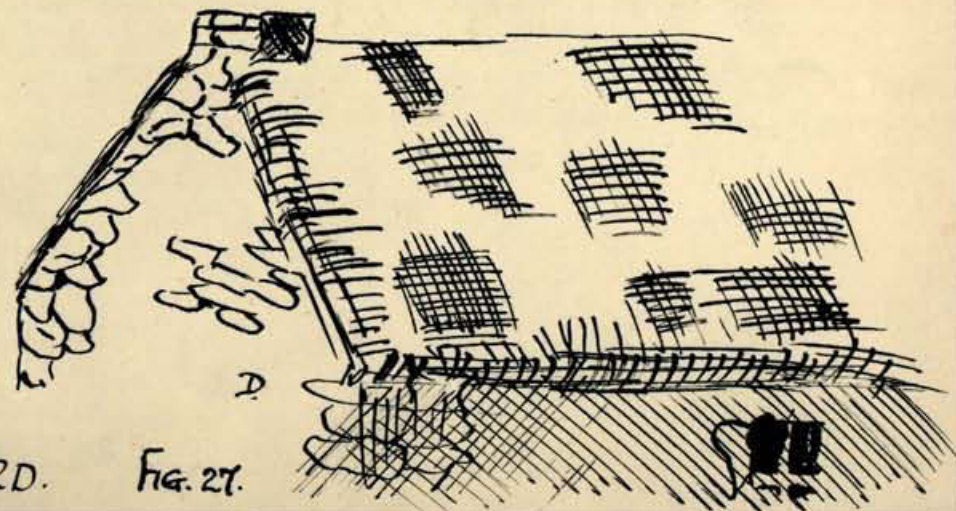
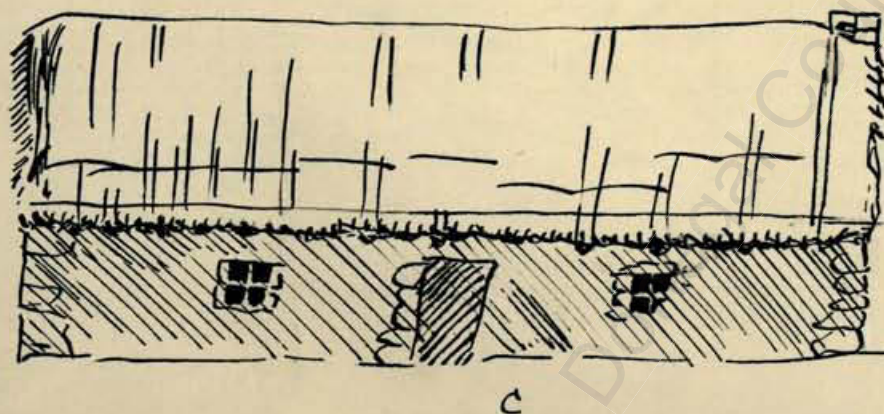
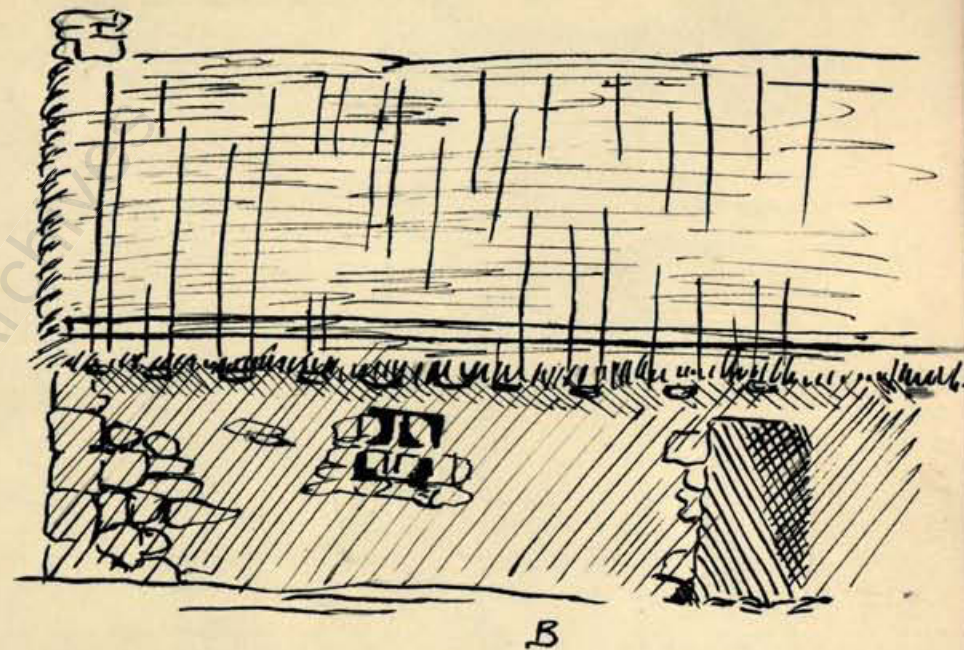
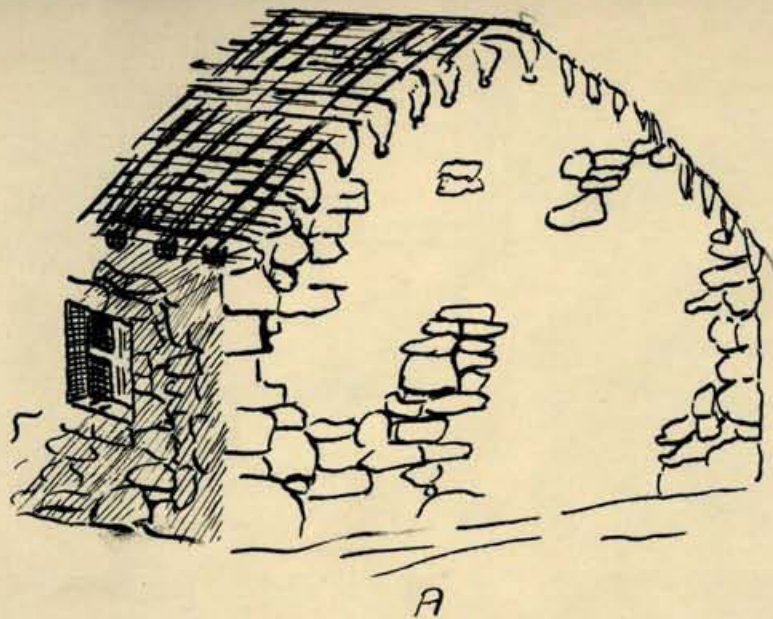
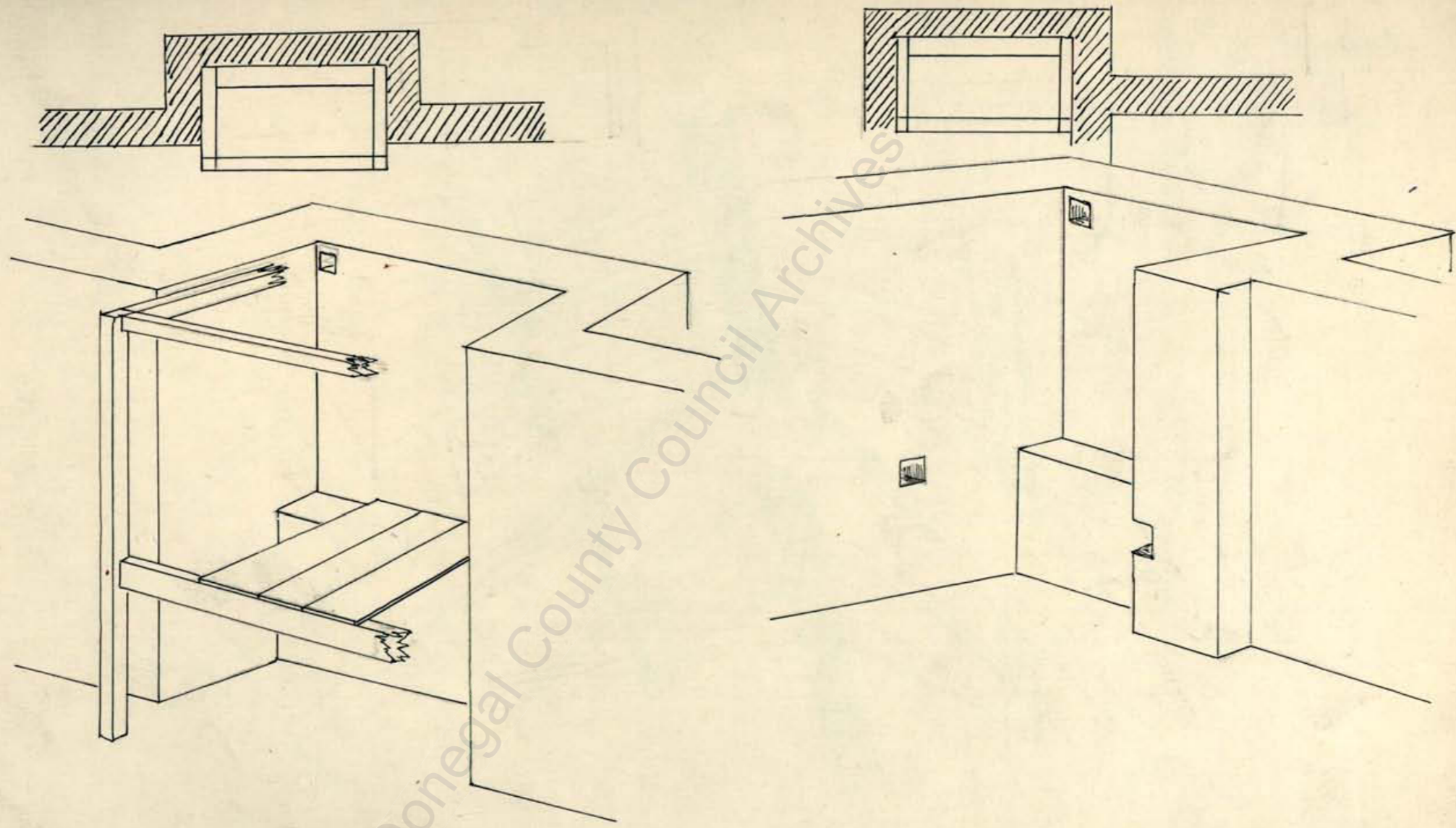

FIG. 26



ROOF TYPES ON W. SEABOARD. FIG. 27.



Wall-bed.

FIG. 28

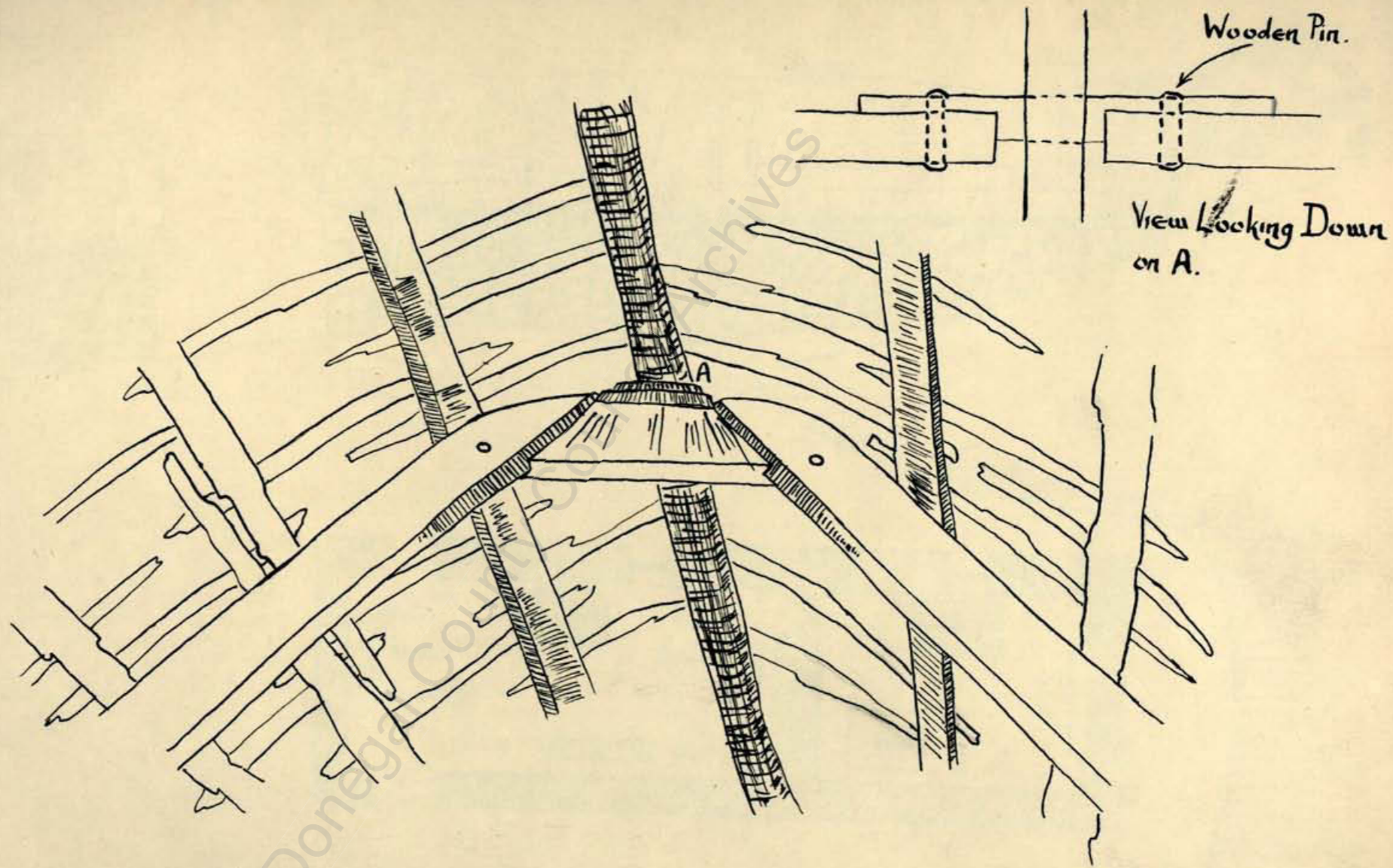

Structural features of roof

Fig. 29.

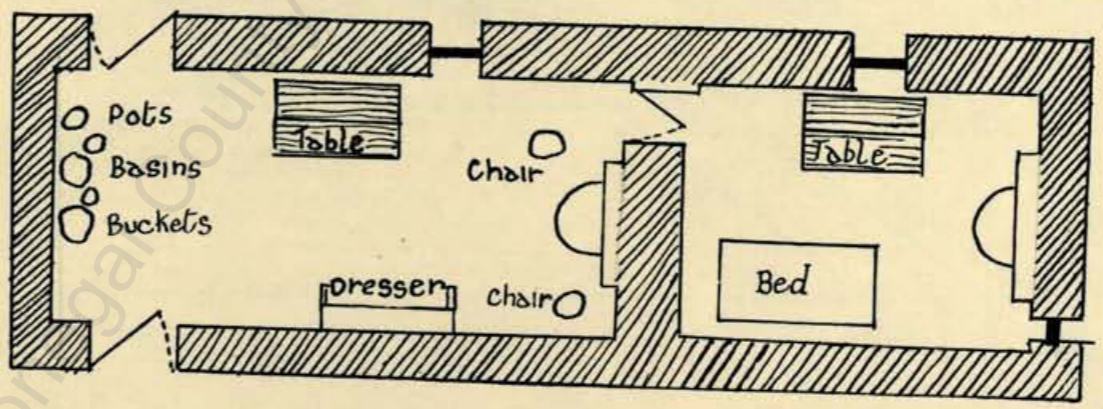
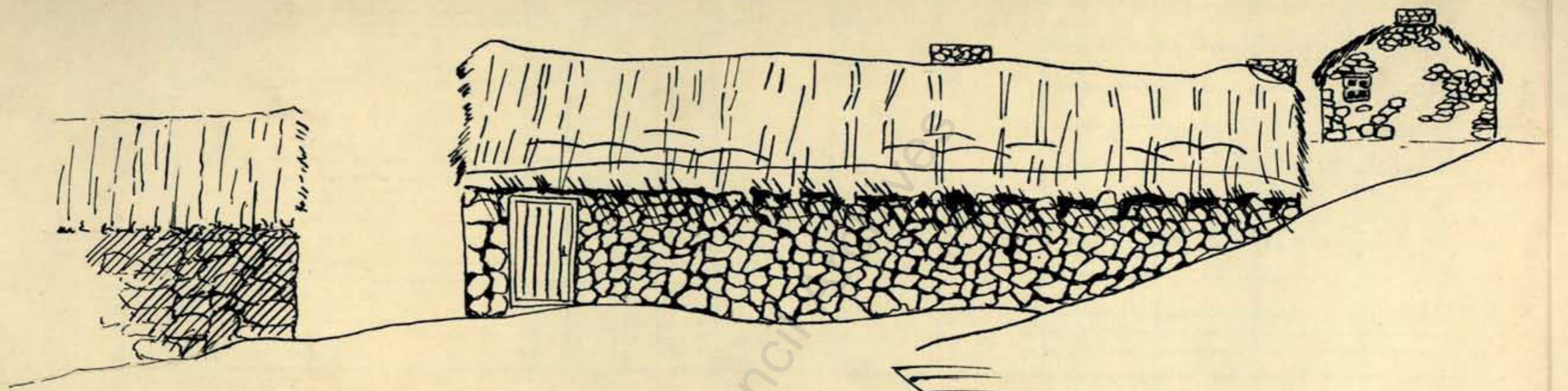

Dunglow.

FIG. 30.

N

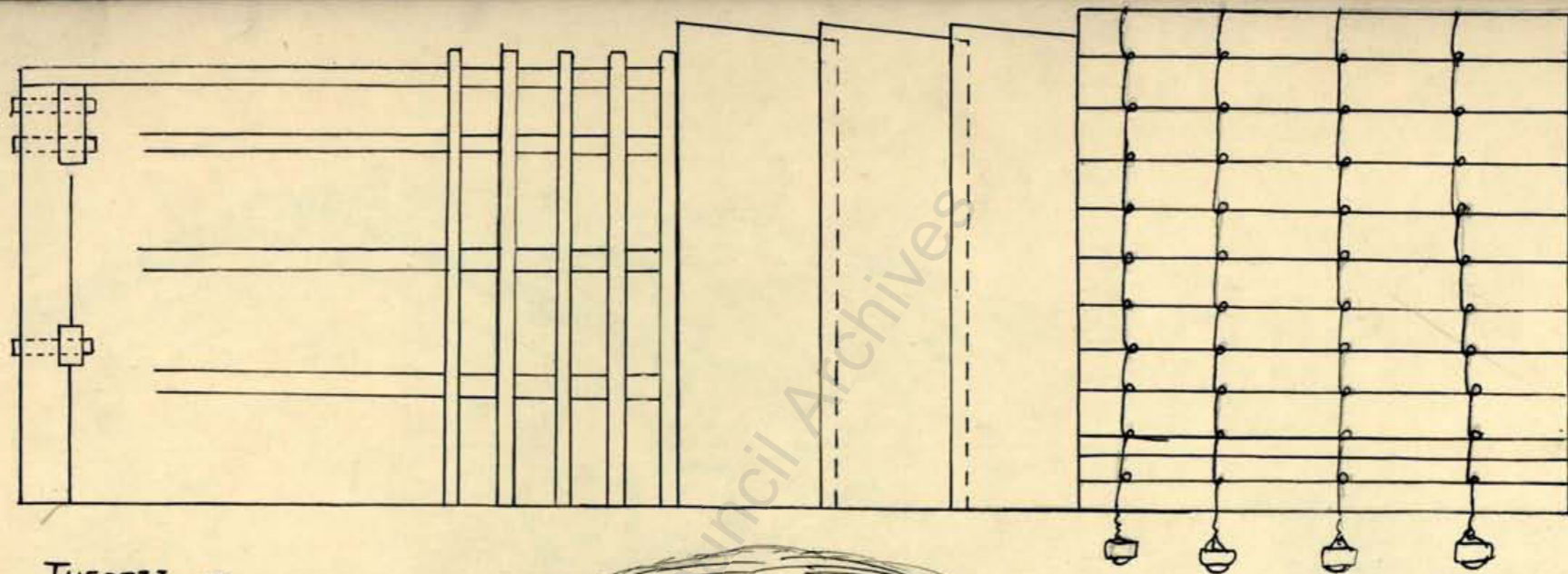

ELEVATION

THEORY OF
ROOF STRUCTURE
(GLENOLUMBKILLE)

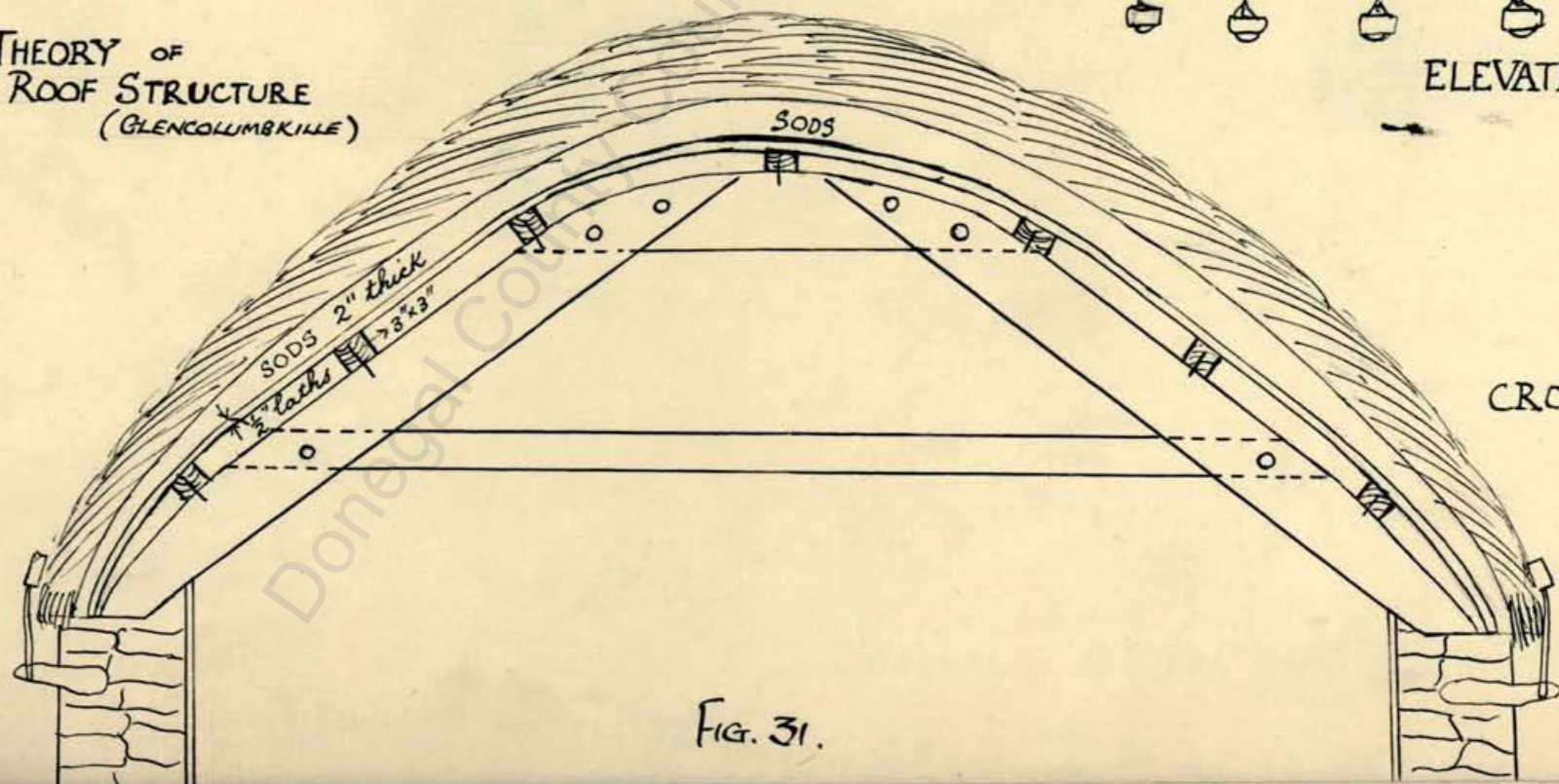

CROSS-SECTION

FIG. 31.

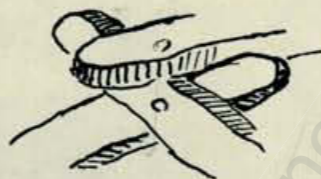
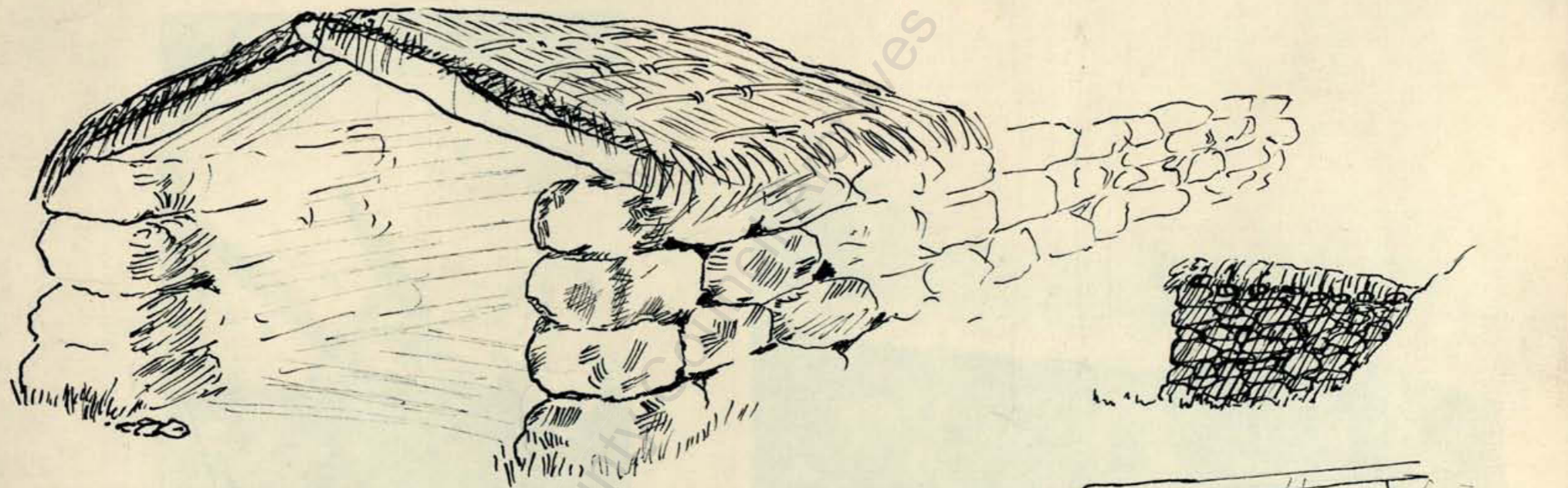

Roof-trees

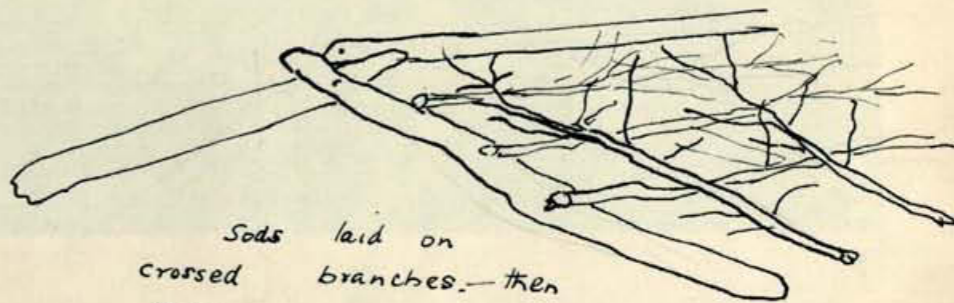

Sods laid on
crossed
branches.—then
thatch

Utilisation of ditch wall. (Golly, Donegal).

FIG. 32.

PLATES



1



2
Upper Finn Valley



3
Knockfola.



4



5
Traveenagh Bay.



6
Gibbstown, Co. Meath.



7
Bally roarty



8 Stranacloc (Owenea valley)



Front View.

9
Strathboy



Rear View

10 Strathboy



11
Allnaquoire (Ranafast)



12. Teelin



13
Drumeen

(Seamus Ó h-Cáirí)
Rann na Gille
Teelin.



14. Teelin



15
Teelin



16 Skathboy



17
Bunbeg



18 Teelin



19
Strathboy



20
cas suzám.



21



House cluster (Einzelhöfe), upper Vorm
valley, Otta, Norway.

22

Influence of local material
on house structure

1. Schistose slab roof
2. Timber walls.
- 3 Lake boulders as base.
(Sogndal - Sogne Fjord).



23.

